

IT - Quando utilizzato come portatile il presente prodotto è adatto solo ad ambienti correttamente isolati o ad un uso occasionale.

EN - When used as portable this product is only suitable for well insulated spaces or occasional use.

RO - Când aparatul este utilizat ca încălzitor portabil, se recomandă folosirea ocazională și numai în spații bine izolate.

PL - Kiedy jest używany jako przenośny Ten produkt jest odpowiedni tylko do sporadycznego użytku lub do stosowania w dobrze izolowanych pomieszczeniach.

NL - Bij gebruik als draagbaar , dit product is uitsluitend geschikt voor goed geïsoleerde plaatsen of voor incidenteel gebruik.

DE - Dieses Produkt ist nur für Räume geeignet, die korrekt isoliert wurden oder für einen gelegentlichen Gebrauch



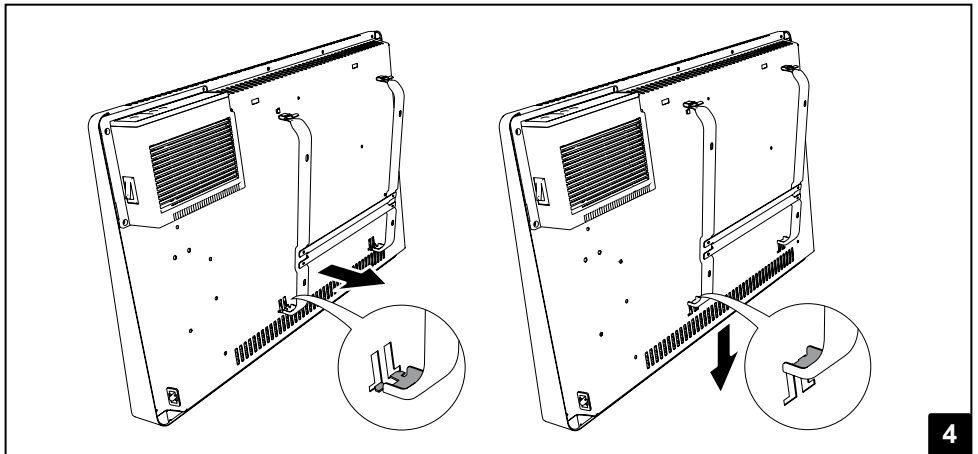
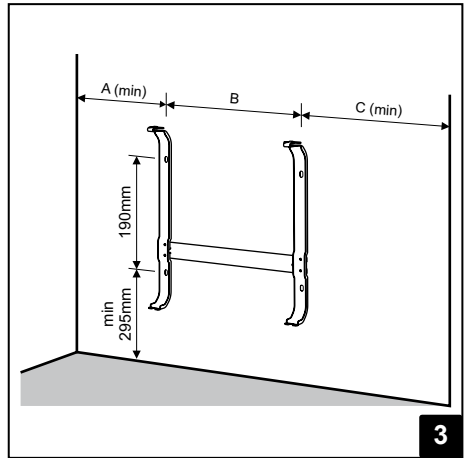
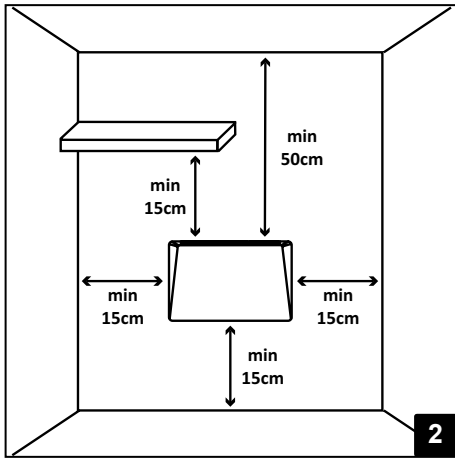
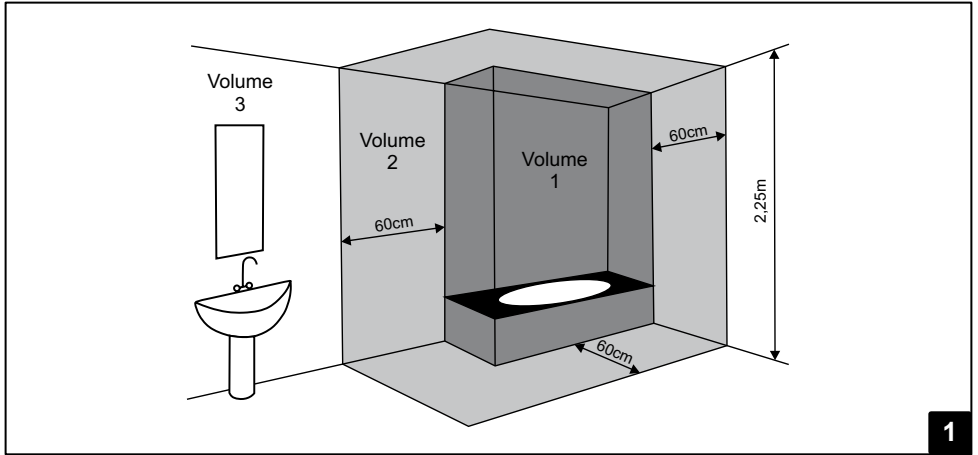

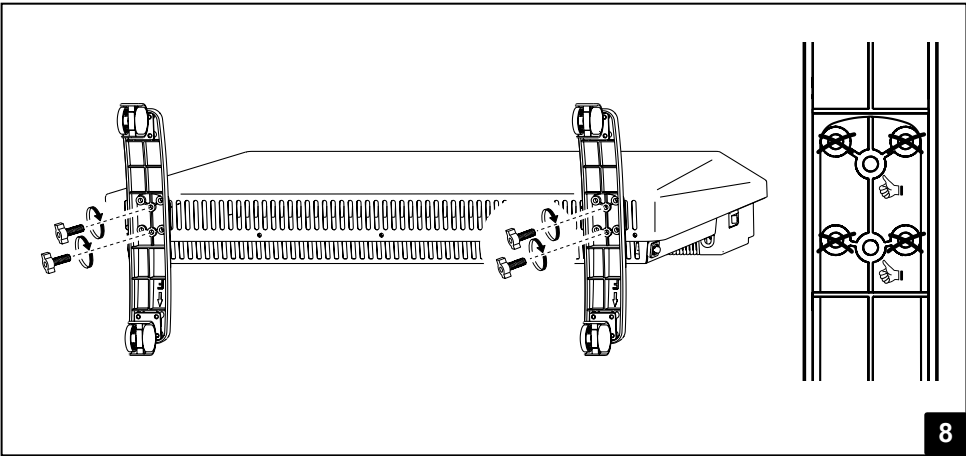
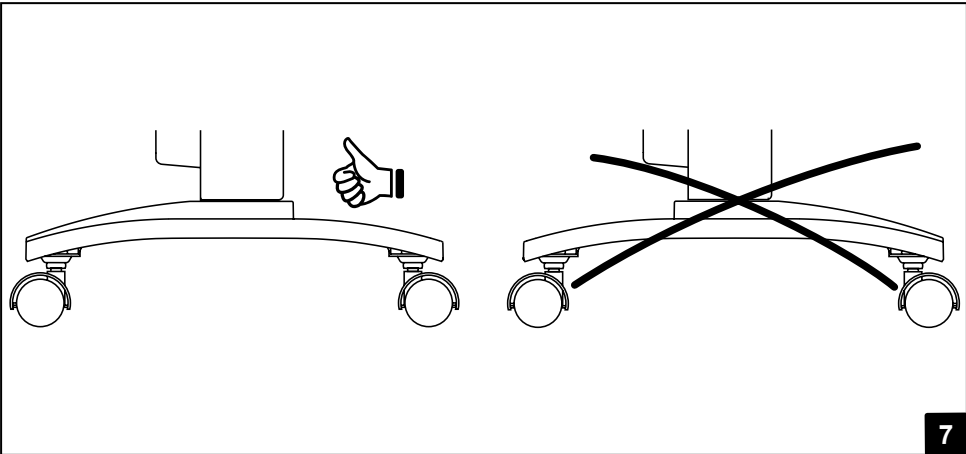
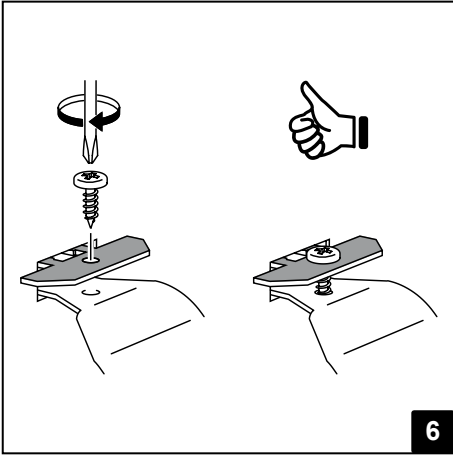
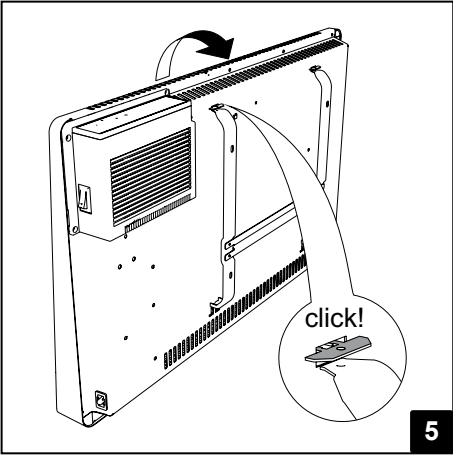

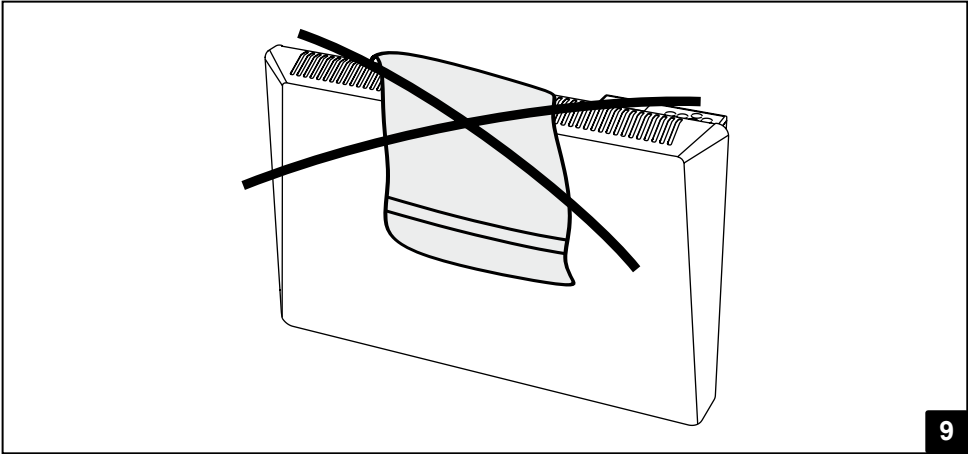

9

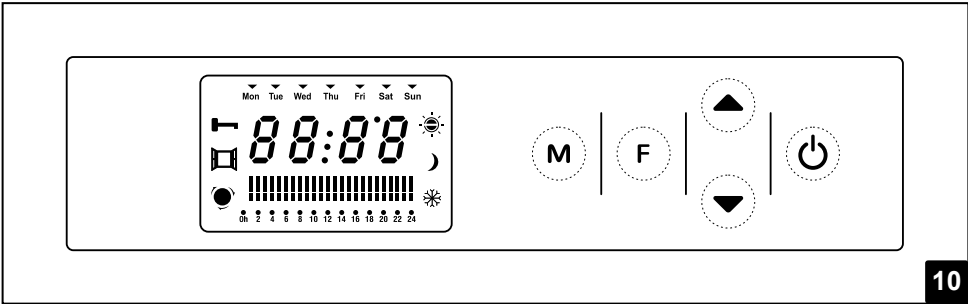

10

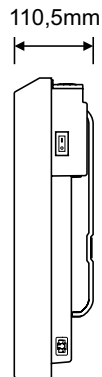
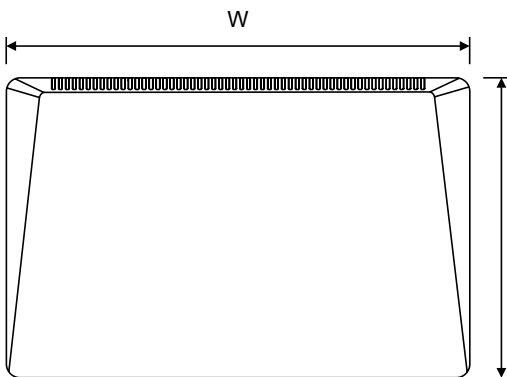

	W
SIRIO 5	450mm
SIRIO 10	650mm
SIRIO 15	850mm
SIRIO 20	1050mm

Si prega di leggere attentamente queste istruzioni, prima di utilizzare il prodotto, in modo da evitare danneggiamenti o comunque il verificarsi di situazioni di pericolo. Qualsiasi utilizzo del prodotto diverso da quanto indicato nel presente manuale può causare incendi, pericoli elettrici o ferite e rende nulla qualsiasi garanzia.

La garanzia non si applica ad alcun difetto, deterioramento, perdita, ferimento o danneggiamento riconducibili ad un uso non corretto del prodotto. Rimangono garantiti tutti i diritti di legge in materia. Nessuna condizione di garanzia può escludere o modificare le condizioni di garanzia regolamentate da leggi dello Stato che non possono essere a nessun titolo escluse o modificate.

Prima di ogni operazione, rimuovere con cura l'imballo e controllare la perfetta integrità del prodotto. Nel caso si evidenziasse dei difetti o danni, non installare né cercare di riparare l'apparecchiatura, ma rivolgersi al rivenditore. Non lasciare l'imballo alla portata dei bambini e smaltire le parti in conformità con le disposizioni vigenti.

1. PER LA VOSTRA SICUREZZA

- Questo prodotto è per uso domestico e non è adatto per l'utilizzo in ambienti commerciali/industriali o su veicoli, imbarcazioni o aeromobili.
- L'apparecchio può essere utilizzato da bambini di età non inferiore a 8 anni e da persone con ridotte capacità fisiche, sensoriali o mentali, o prive di esperienza o della necessaria conoscenza, purché sotto sorveglianza oppure dopo che le stesse abbiano ricevuto istruzioni relative all'uso sicuro dell'apparecchio e alla comprensione dei pericoli ad esso inerenti. I bambini non devono giocare con l'apparecchio. La pulizia e la manutenzione destinata ad essere effettuata dall'utilizzatore non deve essere effettuata da bambini senza sorveglianza.
- I bambini di età inferiore a 3 anni non devono avvicinarsi al prodotto se non costantemente supervisionati.
- I bambini di età compresa fra 3 e 8 anni possono solamente accendere e spegnere l'apparecchio purché esso sia stato installato e posizionato secondo le normali condizioni d'uso e loro siano supervisionati o adeguatamente istruiti riguardo al corretto e sicuro utilizzo del prodotto e ne abbiano compresa la pericolosità. I bambini di età compresa fra 3 e 8 anni non possono collegare il prodotto, regolarlo, pulirlo o effettuare manutenzione.
- **ATTENZIONE: Alcune parti di questo prodotto possono diventare molto calde e causare bruciate. Particolare attenzione deve essere prestata in presenza di bambini o persone**

vulnerabili.

- Assicuratevi che l'alimentazione di rete corrisponda ai dati di targa: 230V~, 50Hz.
- Il prodotto ha un doppio livello di protezione dall'acqua: IPX0 quando utilizzato come portatile e IPX4 quando installato a muro. Rispettate le normative del paese in cui viene installato il prodotto relative all'utilizzo nei diversi ambienti. Quando installato a muro può essere utilizzato nei bagni PURCHE' NON SIA INSTALLATO ENTRO IL PERIMETRO DELLA VASCA O DELLA DOCCIA. Il prodotto non può quindi essere installato nelle aree indicate come Volume 1 nello schema di figura 1. Se utilizzato come portatile accertarsi che il convettore non sia accessibile dalla vasca da bagno, dalla doccia o da una piscina.
- Durante il funzionamento collocate il convettore in una posizione sicura ovvero:
 - ad almeno 1m da oggetti infiammabili o mobili;
 - lasciando libera la griglia di uscita dell'aria: nessun oggetto deve essere presente nel raggio di 1m dalla griglia di uscita;
 - mai posizionato immediatamente sotto ad una presa di corrente.
- Non lasciate che animali o bambini giochino o tocchino il convettore. Attenzione! Durante il funzionamento la griglia di uscita dell'aria può diventare molto calda (oltre 90°C);
- **IMPORTANTE: per evitare surriscaldamenti non ricoprite mai il prodotto.** Non appoggiate mai alcun oggetto o coperta sull'apparecchio mentre è in funzione. Questo è chiaramente scritto sull'apparecchio o illustrato dal simbolo



- Non utilizzate il convettore in stanze sature di gas esplosivi, di vapori generati da solventi e vernici o comunque di vapori/gas infiammabili.
- Se il cavo è danneggiato e dovete sostituirlo non eseguite questa operazione da soli, riportate il convettore ad un centro di riparazioni autorizzato perché è richiesto l'intervento di personale specializzato al fine di evitare qualunque rischio di danneggiamento.
- Il convettore deve essere posizionato in modo tale che la presa di

alimentazione sia sempre raggiungibile.

- Non installate il prodotto su pareti di materiale sintetico.
- Non utilizzate questo convettore se è caduto;
- Non utilizzare se vi sono segni visibili di danneggiamento del convettore;
- Utilizzare il convettore su una superficie orizzontale e stabile;
- **ATTENZIONE:** Non utilizzate il convettore in stanze di piccole dimensioni quando esse sono occupate da persone non in grado di uscire dalla stanza da sole a meno che non siano sotto la supervisione di qualcuno responsabile per la loro sicurezza;
- **ATTENZIONE:** Per ridurre il rischio di incendio tenete tessuti, tende o qualsiasi altro materiale infiammabile ad almeno 1m di distanza dalla griglia di uscita dell'aria.

2. MONTAGGIO A MURO

- Installare il convettore in posizione orizzontale con la griglia di uscita dell'aria rivolta verso l'alto.
- Questo convettore è in doppio isolamento elettrico (classe II) pertanto la connessione di terra non è richiesta.
- Questo convettore deve essere installato seguendo le norme in vigore nel paese di installazione.
- In ambienti umidi come bagni e cucine la connessione alla rete elettrica deve essere ad almeno 25 cm di altezza dal suolo. I dispositivi di disconnessione dalla rete di alimentazione devono consentire la disconnessione completa nelle condizioni della categoria di sovratensioni III.
- L'apparecchio deve essere installato a muro, rispettando le distanze minime dal soffitto, dal pavimento e dalle pareti laterali indicate in figura 2. A tale scopo la staffa di supporto deve essere fissata al muro rispettando le distanze indicate in figura 3 e nella tabella sotto riportata.
- Per procedere con l'installazione:
 - Rimuovete la staffa dal prodotto;
 - Praticate nel muro 4 fori rispettando le distanze indicate in figura 3 e specificate nella seguente tabella:

MODELLO	A	B	C
SIRIO 5	205mm	180mm	357mm
SIRIO 10	290mm	260mm	400mm
SIRIO 15	270mm	480mm	400mm
SIRIO 20	250mm	700mm	400mm

- Fissate la staffa utilizzando i tasselli e le viti adatti per il tipo di parete;
- Verificate che le distanze minime precedentemente descritte siano soddisfatte;
- Avvicinate il prodotto alla staffa fino ad inserire i ganci inferiori della staffa nelle fessure presenti sul pannello posteriore come indicato in figura 4;
- Fate ruotare la parte superiore del prodotto verso il muro fino a bloccarlo assicurandovi di far scattare i 2 ganci superiori della staffa come indicato in figura 5;
- Bloccate i 2 ganci superiori della staffa usando le viti in dotazione come indicato in figura 6.

3. FISSAGGIO DELLE RUOTE (OPZIONALI)

- Il convettore può essere anche utilizzato come prodotto portatile acquistando le ruote fornite separatamente.
- Per fissare le ruote:
 - verificare il corretto orientamento secondo quanto indicato in figura 7;
 - fissare ognuno dei 2 supporti con le ruote utilizzando le viti in dotazione come indicato in figura 8. Le viti possono essere fissate a mano e non richiedono l'utilizzo di un utensile.

4. DESCRIZIONE DEI COMANDI

- Il convettore è dotato di un pulsante di accensione e spegnimento posto sul lato destro. Spegnendo il prodotto i componenti elettrici interni non saranno più sotto tensione.
- I seguenti controlli sono integrati sul frontale del prodotto (figura 10):



Display multifunzione per visualizzare lo stato di funzionamento e di attivazione delle funzioni:

	Comfort
	Comfort - 1 °C
	Comfort - 2°C
	Eco
	Antigelo
	Blocco tastiera
	Rilevamento finestra aperta
	Riscaldamento in corso



Pulsante di selezione della modalità di funzionamento.



Pulsante di selezione delle funzioni speciali.



Pulsante di navigazione all'interno dei vari menu.



Pulsante per attivare o disattivare lo stato di standby.

5. ACCENSIONE E SPEGNIMENTO



L'alimentazione del prodotto è controllata tramite un pulsante elettromeccanico di accensione e spegnimento. Spegner re il prodotto tramite questo pulsante causa l'interruzione di alimentazione della scheda elettronica e la conseguente cancellazione dell'orario e del giorno correnti. Raccomandiamo di utilizzare questo interruttore solo in caso non si debba usare il prodotto per un periodo prolungato di tempo e di utilizzare invece il pulsante di Accensione / Stand-by presente nel pannello comandi in caso di breve interruzione di utilizzo del prodotto. In questo modo non si perderanno le impostazioni di regolazione precedentemente immesse.

Al momento dell'accensione il convettore attiva l'ultima modalità utilizzata prima dello spegnimento o della mancanza di alimentazione. L'orario viene reimpostato alle 12:00 e il giorno della settimana a lunedì.

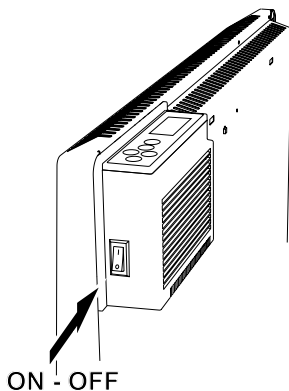

Usare il pulsante di Accensione / Stand-by per accendere e spegnere il convettore senza perdere l'orario memorizzato.

ACCENSIONE - STANDBY

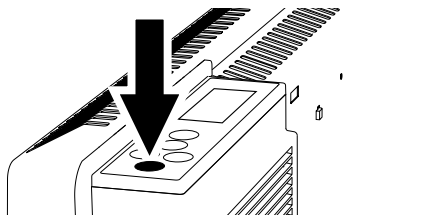

6. MODALITÀ DI FUNZIONAMENTO

M

La pressione del pulsante  permette di selezionare una delle seguenti 6 modalità di funzionamento:



Modalità COMFORT

Il convettore funziona per raggiungere e mantenere la temperatura di Comfort impostata.

Il simbolo corrispondente alla modalità Comfort si accende.

Il simbolo relativo al riscaldamento si accende quando l'elemento riscaldante è in funzione.

In questa modalità è disponibile la funzione di rilevamento finestra aperta (vedere il pulsante FUNZIONI).

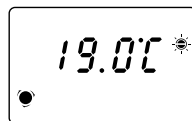

Modalità COMFORT-1

Il convettore funziona per raggiungere e mantenere la temperatura di Comfort impostata ridotta di 1°C.

Il simbolo corrispondente alla modalità Comfort-1 si accende.

Il simbolo relativo al riscaldamento si accende quando l'elemento riscaldante è in funzione.

In questa modalità è disponibile la funzione di rilevamento finestra aperta (vedere il pulsante FUNZIONI).

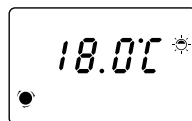

Modalità COMFORT-2

Il convettore funziona per raggiungere e mantenere la temperatura di Comfort impostata ridotta di 2°C.

Il simbolo corrispondente alla modalità Comfort-2 si accende.

Il simbolo relativo al riscaldamento si accende quando l'elemento riscaldante è in funzione.

In questa modalità è disponibile la funzione di rilevamento finestra aperta (vedere il pulsante FUNZIONI).

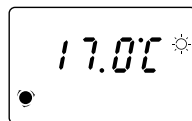

Modalità ECO

Il convettore funziona per raggiungere e mantenere la temperatura di Comfort impostata ridotta di 3,5°C.

Il simbolo corrispondente alla modalità Eco si accende.

Il simbolo relativo al riscaldamento si accende quando l'elemento riscaldante è in funzione.

In questa modalità è disponibile la funzione di rilevamento finestra aperta (vedere il pulsante FUNZIONI).

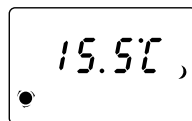

Modalità ANTIGELO

Il termostato viene automaticamente impostato alla temperatura di 7±3°C.

Il simbolo corrispondente alla modalità Antigelo si accende.

Il simbolo relativo al riscaldamento si accende quando l'elemento riscaldante è in funzione.

In questa modalità la funzione di rilevamento finestra aperta non è disponibile.

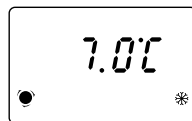

Modalità PROGRAMMATA

Il convettore funziona per raggiungere e mantenere la temperatura impostata nel programma settimanale (vedere il paragrafo relativo alla PROGRAMMAZIONE SETTIMANALE).

Il simbolo corrispondente alla modalità di funzionamento (Comfort, Comfort-1, Comfort-2, Eco o Antigelo) si accende in funzione delle impostazioni previste per l'ora e il giorno correnti.

In questa modalità è disponibile la funzione di rilevamento finestra aperta (vedere il pulsante FUNZIONI).



7. FUNZIONI SPECIALI

F

La pressione del pulsante  permette di selezionare una delle seguenti 3 funzioni speciali:



Funzione di RESET

Attivando questa funzione tutte le impostazioni vengono ripristinate al valore di fabbrica iniziale. La temperatura di Comfort viene impostata pari a 19,0°C, il programma preimpostato quello descritto nell'apposita sezione e la funzione di rilevamento finestra aperta viene disattivata.

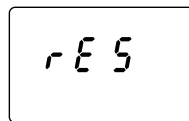

Per eseguire il RESET premere per almeno 5 secondi il tasto .

Il convettore viene automaticamente impostato in modalità Comfort

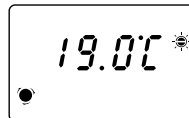

Funzione di RILEVAMENTO FINESTRA APERTA

Questa funzione permette di identificare l'apertura di una finestra e di impostare automaticamente il modo di funzionamento Antigelo.

Qualora venga rilevata una brusca riduzione della temperatura ambiente durante il normale funzionamento del prodotto, viene attivata automaticamente la modalità antigelo per ridurre lo spreco di energia. Il simbolo della finestra e quello antigelo lampeggiano per indicare l'attivazione della funzione.

Il ripristino del normale funzionamento non è automatico ma si ottiene premendo uno qualsiasi dei 5 tasti del prodotto.

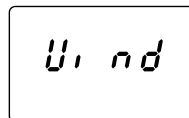



Il corretto funzionamento di questa funzione può dipendere dal posizionamento del prodotto del locale, dalla presenza di spifferi, dalla temperatura esterna e dal tempo di apertura della finestra.

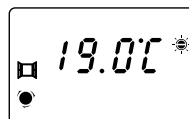

Attivare la funzione premendo il tasto .

Il simbolo della finestra si accende sul display.



Disattivare la funzione premendo il tasto .

Il simbolo della finestra si spegne.

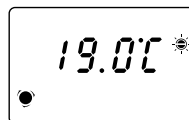



Funzione di BLOCCO

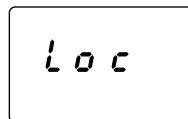

Attivando questa funzione tutti i tasti vengono disattivati in modo da impedire modifiche non desiderate delle impostazioni di funzionamento.

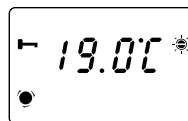

Attivare la funzione premendo per almeno 5 secondi il tasto .

Il simbolo della chiave si accende sul display ed i tasti vengono bloccati.



Disattivare la funzione premendo contemporaneamente per almeno 5" secondi i tasti  e .

Il simbolo della chiave si spegne, i tasti tornano ad essere funzionanti.

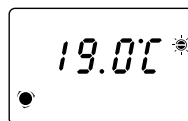

8. CONTROLLO DELLA TEMPERATURA

Il controllo elettronico della temperatura si basa sul valore che l'utente assegna alla temperatura di COMFORT.

I valori delle temperature per le modalità Comfort-1, Comfort-2, Eco e Antigelo sono calcolati automaticamente e non possono essere direttamente modificati dall'utente. La temperatura di riferimento viene sempre indicata sul display unitamente al simbolo che rappresenta la modalità di funzionamento selezionata.

NOTA: La temperatura misurata tramite il sensore interno al prodotto indica sempre la temperatura ambiente nelle immediate vicinanze del prodotto e potrebbe differire dalla temperatura misurata con altri strumenti in altre aree della stanza. Questa differenza può dipendere da vari fattori, come ad esempio:

- La posizione dell'installazione: alcune aree della stanza possono risentire di correnti o sacche d'aria calda che possono modificare la misurazione del sensore;
- L'installazione su un muro perimetrale esterno, che essendo normalmente più freddo dei muri interni, può provocare una misurazione più bassa della temperatura rispetto alla temperatura ambiente reale;
- Condizioni instabili: ogni valutazione deve essere fatta in condizioni stabili di funzionamento. Per questo motivo la temperatura Comfort non dovrebbe essere cambiata prima che siano trascorsi 60 minuti dalla precedente modifica. Non è possibile infatti valutare se la temperatura ambiente è mantenuta correttamente dal prodotto se il livello di temperatura è continuamente modificato in un breve periodo di tempo.

Se la differenza tra la temperature impostata e la temperature ambiente è rilevata in condizioni di stabilità, calcolate tale differenza e quindi aumentate o diminuite il livello di temperature Comfort sul prodotto dell'esatto valore della differenza calcolata.

9. IMPOSTAZIONE DEL GIORNO E DELL'ORA

Per impostare l'orario ed il giorno correnti procedere come segue:



Premere il tasto (M) fino a selezionare la modalità programmata



3" Premere il tasto (M) per almeno 3 secondi fino a quando il giorno della settimana non inizia a lampeggiare.



Usare i tasti (▲) e (▼) per selezionare il giorno corrente.



Premere il tasto (M) per passare dall'impostazione del giorno a quella dell'ora.

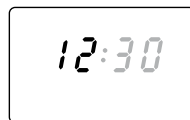

Usare i tasti (▲) e (▼) per selezionare l'ora corrente.



Premere il tasto (M) per passare dall'impostazione dell'ora a quella dei minuti.

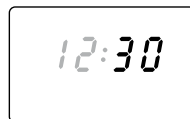

Usare i tasti (▲) e (▼) per selezionare i minuti correnti.



Premere il tasto (M) per concludere l'impostazione e tornare in modalità Programmata.



10. PROGRAMMAZIONE SETTIMANALE

La programmazione settimanale permette di impostare, per ogni ora del giorno e per ogni giorno della settimana, la modalità di funzionamento desiderata. Il convettore viene fornito preimpostato con il seguente programma settimanale:

Lunedì - Venerdì

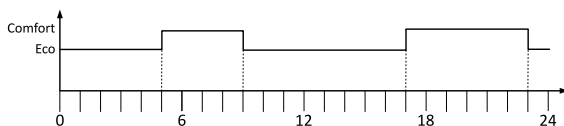

Sabato - Domenica

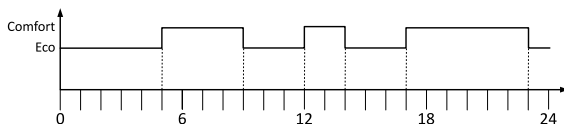

Per visualizzare/modificare il programma procedere come segue:



Premere il tasto **(M)** fino ad attivare la modalità di funzionamento Programmata.



Premere il tasto **(F)** per almeno 3 secondi per entrare in modalità di visualizzazione/modifica della programmazione. Il primo giorno della settimana, la temperatura impostata e il relativo simbolo iniziano a lampeggiare.

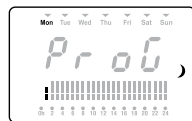

Usare i tasti **(▲)** e **(▼)** per selezionare le diverse ore del giorno ed il tasto **(M)** per cambiarne la modalità di funzionamento di ciascuna ora.



Ad ogni pressione del tasto **(M)** la modalità di funzionamento cambia seguendo la sequenza:



Comfort > Comfort-1 > Comfort-2 > Eco > Antigelo

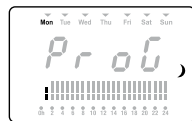

Premere il tasto **(F)** per passare alla visualizzazione/modifica del giorno successivo.



Qualora si desideri copiare le impostazioni di un giorno su un altro (seguente) procedere come segue:



Selezionare il giorno da cui si desidera copiare le impostazioni e premere contemporaneamente i tasti **(▲)** e **(▼)**. La scritta "COPY" appare sul display a conferma dell'avvenuta memorizzazione.

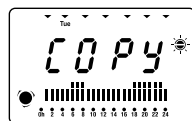

Premere il tasto **(F)** per selezionare il giorno che si desidera programmare con il medesimo programma appena copiato.



Premere nuovamente insieme i tasti **(▲)** e **(▼)** per incollare il programma sul giorno selezionato. Sul display torna ad apparire la scritta PROG.



Premere il tasto **(F)** per passare alla visualizzazione/modifica del giorno successivo.

La procedura termina premendo nuovamente il tasto **(F)** dopo la visualizzazione/modifica dell'ultimo giorno della settimana. Il display torna a visualizzare le impostazioni di programmazione per il giorno e l'ora correnti.



11. RISOLUZIONE DEI PROBLEMI

- In caso di surriscaldamento, il protettore di sicurezza all'interno del prodotto disattiva la resistenza. In questo caso:
 - Spegnerne il convettore e lasciarlo raffreddare per circa 15/20 minuti;
 - Eliminare ogni possibile causa di surriscaldamento (es.: ostruzioni in corrispondenza della griglia di uscita dell'aria, residui di sporcizia sul prodotto ecc.);
 - Riaccendere il convettore e controllare il corretto funzionamento.

12. MANUTENZIONE

- Questo prodotto non richiede manutenzione speciale.
- Pulire il prodotto con un panno asciutto almeno una volta ogni 6 mesi.
- In caso il prodotto debba essere riparato, rivolgersi ad un centro di assistenza qualificato.
- In caso di sostituzione del cavo di alimentazione, utilizzare un tipo 2x0,75mm² H05RR-F o 2x1,00mm² H05RR-F <HAR> in funzione del modello di convettore. Tale sostituzione deve essere effettuata da personale tecnico qualificato e mai dall'utente finale per evitare un danneggiamento del prodotto e ogni rischio per la persona.

13. COMUNICAZIONI DI LEGGE



Tutela dell'ambiente e riciclaggio

Affinché il vostro apparecchio non subisca danni durante il trasporto, esso è stato imballato con cura. Per contribuire alla tutela del nostro ambiente, vi chiediamo di smaltire in modo appropriato il materiale utilizzato per l'imballaggio dell'apparecchio.

Smaltimento degli apparecchi usati

Gli apparecchi che recano il contrassegno riportato a fianco non devono essere smaltiti insieme ai rifiuti urbani, ma vanno raccolti e smaltiti separatamente. Lo smaltimento degli apparecchi usati va eseguito a regola d'arte, in conformità con le prescrizioni e leggi vigenti localmente in materia.

Informazioni obbligatorie per gli apparecchi per il riscaldamento d'ambiente locale elettrici

Identificativo del modello: SIRIO					
Dato	Sim-bolo	Valore	Unità	Dato	Unità
Potenza termica				Tipo di potenza termica, solo per gli apparecchi per il riscaldamento d'ambiente locale elettrici ad accumulo (indicare una sola opzione)	
Potenza termica nominale	P_{nom}	(*)	kW	controllo manuale del carico termico, con termostato integrato	no
Potenza termica minima (indicativa)	P_{min}	(**)	kW	controllo manuale del carico termico con riscontro della temperatura ambiente e/o esterna	no
Massima potenza termica continua	$P_{max,c}$	(***)	kW	controllo elettronico del carico termico con riscontro della temperatura ambiente e/o esterna	no
Consumo ausiliario di energia elettrica				potenza termica assistita da ventilatore	no
Alla potenza termica nominale	$e_{l,max}$	0,000	kW	Tipo di potenza termica/controllo della temperatura ambiente (indicare una sola opzione)	
Alla potenza termica minima	$e_{l,min}$	0,000	kW	potenza termica a fase unica senza controllo della temperatura ambiente	no
In modo stand-by	$e_{l,SB}$	0,162	W	due o più fasi manuali senza controllo della temperatura ambiente	no
				con controllo della temperatura ambiente tramite termostato meccanico	no
				con controllo elettronico della temperatura ambiente	no
				con controllo elettronico della temperatura ambiente e temporizzatore giornaliero	no
				con controllo elettronico della temperatura ambiente e temporizzatore settimanale	si
				Altre opzioni di controllo (è possibile selezionare più opzioni)	
				controllo della temperatura ambiente con rilevamento di presenza	no
				controllo della temperatura ambiente con rilevamento di finestre aperte	si
				con opzione di controllo a distanza	no
				con controlli di avviamento adattabile	no
				con limitazione del tempo di funzionamento	no
				con termometro a globo nero	no
Contatti	Ermete Giudici S.p.A. - via L. da Vinci, 27 - 20090 Segrate (MI) Italy				

(*)	SIRIO 5 = 0,50	SIRIO 10 = 1,00	SIRIO 15 = 1,50	SIRIO 20 = 2,00
(**)	SIRIO 5 = 0,25	SIRIO 10 = 0,50	SIRIO 15 = 0,75	SIRIO 20 = 1,00
(***)	SIRIO 5 = 0,50	SIRIO 10 = 1,00	SIRIO 15 = 1,50	SIRIO 20 = 2,00

Before operating the convector, please read these instructions thoroughly to avoid damage and hazardous situations. Any use of this convector other than that stipulated in this instruction manual may cause fire, electric shock or injury, and voids all warranties.

Warranty does not apply to any defect, deterioration, loss, injury or damage caused by, or as a result of, the misuse or abuse of this heater. The rights dictated by State law are not prejudiced. None of the terms of this warranty are to be taken as excluding any conditions or warranties implied by State law, which cannot be excluded or modified.

Before any operation remove the packaging and check product integrity. In case of defects or damages do not try to repair it yourself but contact your dealer.

Do not let children play with the packaging and protect the environment by disposing of the packaging in accordance with the national regulations for waste processing.

1. FOR YOUR SAFETY

- This appliance is intended for normal household use and not for use in commercial/industrial environment, in vehicles or on board ships or aircrafts.
- This appliance can be used by children aged from 8 years and above and persons with reduced physical, sensory or mental capabilities or lack of experience and knowledge if they have been given supervision or instruction concerning use of the appliance in a safe way and understand the hazards involved. Children shall not play with the appliance. Cleaning and user maintenance shall not be made by children without supervision.
- Children of less than 3 years should be kept away unless continuously supervised.
- Children aged from 3 years and less than 8 years shall only switch on/off the appliance provided that it has been placed or installed in its intended normal operating position and they have been given supervision or instruction concerning use of the appliance in a safe way and understand the hazards involved. Children aged from 3 years and less than 8 years shall not plug in, regulate and clean the appliance or perform user maintenance.
- **CAUTION — Some parts of this product can become very hot and cause burns. Particular attention has to be given where children and vulnerable people are present.**
- Make sure that your supply rating corresponds to what specified on the rating plate: 230V~, 50Hz.

- This convector has a double water protection level: IPX0 when used as portable and IPX4 when wall-mounted. Respect the regulations of the country concerned about its use in different environments. It can therefore be used in bathrooms or other areas subject to humidity AS LONG AS IT IS NOT INSTALLED WITHIN THE PERIMETER OF BATH TUBS OR SHOWERS. This means that it cannot be installed in the areas marked as VOLUME 1 in picture 1. If used as portable do not use this heater in the immediate surroundings of a bath, a shower or a swimming pool;
- During function, place the convector in a safe position:
 - at least 1m far from inflammable objects or furnitures;
 - leaving not less than 1m of free space in front of the convector;
 - not located immediately below a socket-outlet.
- Do not leave animals or children touch or play with the appliance. Pay attention! The air outlet grille gets hot during operation (more than 90°C)
- **WARNING: In order to avoid overheating, do not cover the heater.** Do not hang anything on the heater and do not cover it while it's working. This is clearly written on the cover of the product or shown by the symbol



- Do not use the heater in rooms with explosive gas or while using inflammable solvents or varnish or glues.
- If the cordset is damaged and you have to change it, do not do the job yourselves! Take the product to an after sales authorised repair centre or to a person with similar skill and knowledge, in order to avoid any risk of danger.
- The appliance must be positioned so that the plug is always accessible.
- Do not mount the product on walls made of synthetic material.
- Do not use this heater if it has been dropped;
- Do not use if there are visible signs of damage to the heater;
- Use this heater on a horizontal and stable surface;
- **WARNING: Do not use this heater in small rooms when they are occupied by persons not capable of leaving the room on their own,**

unless constant supervision is provided.

- **WARNING:** To reduce the risk of fire, keep textiles, curtains, or any other flammable material a minimum distance of 1 m from the air outlet.

2. WALL MOUNTING

- Fix the convector in horizontal position with the air outlet grid upward;
- This convector is fitted with a double electrical insulation circuit (class II) and therefore does not require earth connection.
- This heater must be correctly installed in compliance with the regulations in force in the country of installation.
- In wet spaces like bathrooms or kitchens, the connection terminal must be installed at least 25 cm above the floor. The electrical connection to the power supply must also be fitted with a two-pole switch with a minimum gap between the contacts that allows complete disconnection according to excess voltage III category conditions.
- The device must be wall-mounted respecting the minimum distances from ceiling, floor and side walls shown in figure 2. The support bracket must be fixed to the wall respecting the distances indicated in figure 3 and specified in the following table. Always observe the minimum distances from walls, furniture and/or objects, as indicated in picture 3.
- To proceed with the installation:
 - Remove the bracket from the product;
 - Drill 4 holes in the wall respecting the distances indicated in figure 3 and specified in the following table:

MODEL	A	B	C
SIRIO 5	205mm	180mm	357mm
SIRIO 10	290mm	260mm	400mm
SIRIO 15	270mm	480mm	400mm
SIRIO 20	250mm	700mm	400mm

- Fix the bracket using the wall plugs and screws suitable for the wall type;
- Verify that the minimum distances previously described are satisfied;
- Approach the product to the bracket until the lower hooks of the bracket are inserted in the slots on the rear panel as shown in figure 4;
- Rotate the upper part of the product towards the wall until it locks, making sure to snap the 2 upper hooks of the bracket as shown in figure 5;
- Lock the 2 upper hooks of the bracket using the supplied screws as shown in figure 6.

3. WHEEL FASTENING (OPTIONAL)









- The convector can also be used as a portable product by purchasing the wheels supplied separately.
- To fix the wheels:
 - check the correct orientation as shown in figure 7;
 - fix each of the 2 supports with the wheels using the screws provided as shown in figure 8. The screws can be fixed by hand and do not require any tool.

4. COMMANDS DESCRIPTION

- The convector is equipped with an on / off button on the right side. When the product is switched off, the internal electrical components will no longer be under tension.
- The following controls are integrated on the front of the product (figure 10):



Multi-function display to view the operation and activation status of the functions.

-  Comfort
-  Comfort - 1 °C
-  Comfort - 2°C
-  Eco
-  Anti freeze
-  Keypad lock
-  Open window detection
-  Heating in progress



Operation mode selection button.



Special functions button.



Navigation menu button.



Enable/disable stand-by mode button.

5. TURNING ON AND OFF



The product is powered by an electromechanical on / off button. Switching off the product pressing this button causes the power supply to the electronic board to be interrupted and the current time and day to be canceled. We recommend using it only if you do not use the product for a long time and instead use the on / stand-by button on the control panel in the event of a short operating interruption of the device. This way you will not lose the adjustment settings previously entered.

When switched on, the convector activates the last mode used before switching off or power failure. The time is reset at 12:00 and the day of the week on Monday.

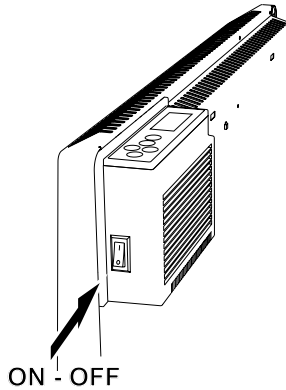

Use the Power / Stand-by button to turn the convector on and off without losing the stored time.

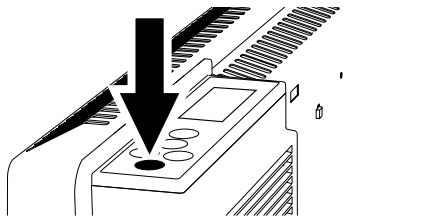

6. OPERATING MODES

M

By pressing  button it is possible to select one of the following 6 operating modes:



COMFORT mode

The convector operates to reach and maintain the set comfort temperature.

The symbol corresponding to the Comfort mode lights up.

The heating symbol lights up when the heating element is operating.

In this mode, the open window detection function is available (see the FUNCTIONS button).

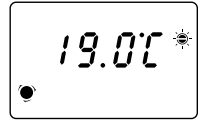

COMFORT mode -1

The convector operates to achieve and maintain the set comfort temperature reduced by 1° C.

The symbol corresponding to the Comfort mode lights up.

The heating symbol lights up when the heating element is operating.

In this mode, the open window detection function is available (see the FUNCTIONS button).

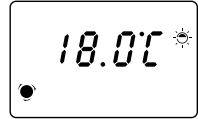

COMFORT mode -2

The convector operates to achieve and maintain the set comfort temperature reduced by 2° C.

The symbol corresponding to the Comfort mode lights up.

The heating symbol lights up when the heating element is operating.

In this mode, the open window detection function is available (see the FUNCTIONS button).

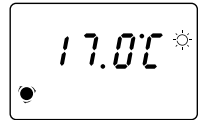

ECO mode

The convector operates to achieve and maintain the set comfort temperature reduced by 3.5° C.

The symbol corresponding to the Eco mode lights up.

The heating symbol lights up when the heating element is operating.

In this mode, the open window detection function is available (see the FUNCTIONS button).

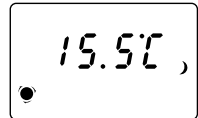

ANTI-FREEZE mode

The thermostat is automatically set at the temperature of 7±3 ° C.

The symbol corresponding to the antifreeze mode lights up.

The heating symbol lights up when the heating element is operating.

In this mode the open window detection function is not available.

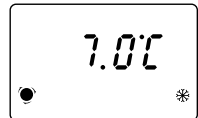

PROGRAMMED mode

The convector works to reach and maintain the temperature set in the weekly program (see the paragraph about WEEKLY PROGRAMMING).

The symbol corresponding to the operating mode (Comfort, Comfort-1, Comfort-2, Eco or Anti-freeze mode) lights up according to the settings for the current time and day.

In this mode, the open window detection function is available (see the FUNCTIONS button).



7. SPECIAL FUNCTIONS

F

By pressing  button it is possible to select one of the following 3 special functions:



RESET function

By activating this function all the settings are restored to the initial factory value. The comfort temperature is set to 19.0 °C, the preset program is the one described in the appropriate section and the open window detection function is deactivated.

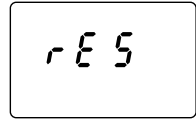

To RESET press the  button for at least 5 seconds.

The convector is automatically set in Comfort mode.

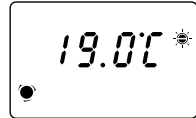

OPEN WINDOW DETECTION function

This function allows to identify the opening of a window and to automatically set the Antifreeze operation mode.



If a sharp reduction of the ambient temperature is detected during the normal operation of the product, the antifreeze mode is automatically activated to reduce energy wastes. The window symbol and the antifreeze symbol flash to indicate that the function is activated.

The restoration of normal operation is not automatic but is obtained by pressing any of the 5 buttons of the product.

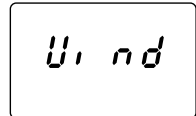



The correct functioning of this function may depend on the positioning of the product in the room, the presence of drafts, the external temperature and the window opening time.

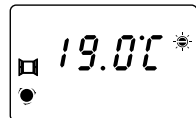

Activate the function by pressing the  button.

The window symbol lights up on the display.



Deactivate the function by pressing the  button.

The window symbol turns off on the display.

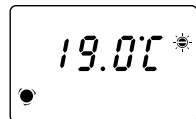



LOCK function

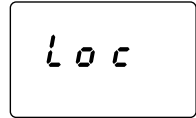

By activating this function all the keys are deactivated to prevent unwanted modifications of the operating settings.

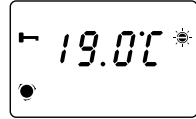

5" Activate the function by pressing the  button for at least 5 seconds.

The key symbol lights up on the display and the keys are locked.



5" Deactivate the function by pressing the  and  buttons simultaneously for at least 5 seconds.

The key symbol turns off, the buttons work again.



8. TEMPERATURE CONTROL

The electronic temperature control is based on the value that the user assigns to the COMFORT temperature.

The temperature values for the Comfort-1, Comfort-2, Eco and Antifreeze modes are automatically calculated and can not be directly modified by the user. The reference temperature is always indicated on the display together with the symbol representing the selected operating mode.

NOTE: The temperature measured by the sensor inside the product always indicates the ambient temperature in the immediate vicinity of the product and may differ from the temperature measured with other instruments in other areas of the room. This difference may depend on various factors, such as:

- The installation position: some areas of the room may be affected by currents or warm air pockets that can change the sensor measurement;
- The installation on an external perimeter wall, which is normally colder than internal walls, may result in a lower temperature measurement than the actual room temperature;
- Unstable conditions: each evaluation must be made under stable operating conditions. For this reason the Comfort temperature should not be changed before 60 minutes have elapsed since the previous modification. In fact, it is not possible to assess whether the room temperature is correctly maintained by the product if the temperature level is continuously modified in a short period of time.

If the difference between the set temperature and the ambient temperature is detected in stability conditions, calculate this difference and then increase or decrease the comfort temperature level on the product of the exact calculated difference value.

9. DATE AND TIME SETTING

To set the current time and date, proceed as follows:



Keep pressing the (M) button until the programmed mode is selected.



Press the (M) button for at least 3 seconds until the day of the week starts to flash.



Use (▲) and (▼) buttons to select the current date.



Press the (M) button to switch between day setting to time setting.

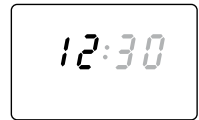

Use (▲) and (▼) buttons to select the current time.



Press the (M) button to switch between hour setting and minutes setting.



Use (▲) and (▼) buttons to select the current minutes.



Press the (M) button to end the setting and return to the Programmed mode.



10. WEEKLY PROGRAMMING

The weekly programming allows you to set the desired operating mode for each hour of the day and for each day of the week. The convector is supplied preset with the following weekly program:

Monday - Friday

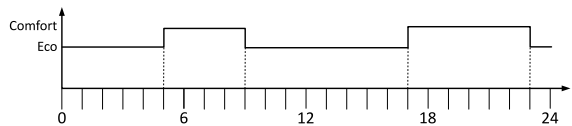

Saturday - Sunday

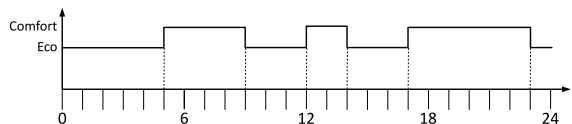

To view / modify the program, proceed as follows:



Press the **(M)** button until the Programmed operating mode is activated.



Press the **(F)** button for at least 3 seconds to enter the view / edit the Programming mode.
On the first day of the week, the set temperature and the corresponding symbol start to flash.

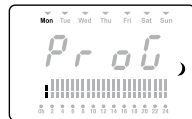

Use **(▲)** and **(▼)** buttons to select the different times of the day and the **(M)** button to change the operating mode of each hour.



Each time the **(M)** button is pressed, the operating mode changes following the sequence:



Comfort > Comfort-1 > Comfort-2 > Eco > Anti-freeze

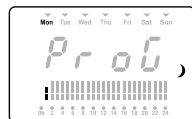

Press the **(F)** button to view / edit the following day.



If you wish to copy the settings for one day to another (following), proceed as follows:



Select the day you want to copy the settings from and press **(▲)** and **(▼)** buttons at the same time.
The word "COPY" appears on the display confirming that it has been saved.

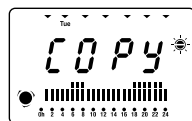

Press the **(F)** button to select the day you want to program with the same program you just copied.

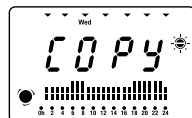

Press **(▲)** and **(▼)** buttons together again to paste the program on the selected day. The word PROG appears on the display.



Press the **(F)** button to view / edit the following day.
The procedure ends by pressing the button again after viewing / editing the last day of the week. The display returns to show the programming settings for the current day and time.



11. TROUBLESHOOTING

- In the event of overheating, the safety device on the appliance automatically disabled the heating elements. In this case:
 - Turn off the convector and allow it to cool down for about 15/20 minutes.
 - Eliminate any other possible reasons for overheating (e.g.: obstructions in front of the air inlet/outlet grilles, build-ups of dirt).
 - Turn on the convector again and check it works correctly.

12. MAINTENANCE

- This product does not require any special maintenance.
- Clean the product with a dry cloth once every 6 months.
- If the product requires repairing, contact an authorised technical service centre.
- When replacing the power cable, use a 2x0,75mm² H05RR-F or 2x1,00 mm² H05RR-F <HAR> type. This operation must be performed by qualified personnel and never by the end user in order to avoid damaging the appliance and jeopardising personal safety.

13. LEGAL NOTICE



Environment and recycling

To avoid damages during transport, your device has been carefully packed. To contribute to the protection of our environment, we ask you to dispose of the packaging materials properly.

Recycling of obsolete appliances

Appliances with this label must not be disposed off with the general waste but they must be collected and disposed of separately. The disposal of used devices must be carried out with precision, in compliance with the locally applicable regulations and laws in force.

Information requirements for electric local space heaters

Model identifier(s): SIRIO					
Item	Symbol	Value	Unit	Item	Unit
Heat output				Type of heat input, for electric storage local space heaters only (select one)	
Nominal heat output	P_{nom}	(*)	kW	manual heat charge control, with integrated thermostat	no
Minimum heat output (indicative)	P_{min}	(**)	kW	manual heat charge control with room and/or outdoor temperature feedback	no
Maximum continuous heat output	$P_{max,c}$	(***)	kW	electronic heat charge control with room and/or outdoor temperature feedback	no
Auxiliary electricity consumption				heat output	no
At nominal heat output	eI_{max}	0,000	kW	Type of heat output/room temperature control (select one)	
At minimum heat output	eI_{min}	0,000	kW	single stage heat output and no room temperature control	no
In standby mode	eI_{SB}	0,162	W	Two or more manual stages, no room temperature control	no
				with mechanic thermostat room temperature control	no
				with electronic room temperature control	no
				electronic room temperature control plus day timer	no
				electronic room temperature control plus week timer	yes
				Other control options (multiple selections possible)	
				room temperature control, with presence detection	no
				room temperature control, with open window detection	yes
				with distance control option	no
				with adaptive start control	no
				with working time limitation	no
				with black bulb sensor	no
Contact details	Your dealer or Ermete Giudici S.p.A. - via L. da Vinci, 27 - 20090 Segrate (MI) Italy				

(*)	SIRIO 5 = 0,50	SIRIO 10 = 1,00	SIRIO 15 = 1,50	SIRIO 20 = 2,00
(**)	SIRIO 5 = 0,25	SIRIO 10 = 0,50	SIRIO 15 = 0,75	SIRIO 20 = 1,00
(***)	SIRIO 5 = 0,50	SIRIO 10 = 1,00	SIRIO 15 = 1,50	SIRIO 20 = 2,00

Citiți cu atenție aceste instrucțiuni înainte de a utiliza produsul, pentru a evita deteriorarea sau apariția unor situații periculoase. Orice utilizari a produsului, altele decât cele indicate în acest manual, poate provoca incendii, pericole electrice sau răniri și va anula orice garanție.

Garanția nu se aplică defecțiunilor, pierderilor, vătămarilor sau deteriorărilor cauzate de utilizarea incorectă a produsului. Toate drepturile legale în acest domeniu rămân garantate. Nici o garanție nu poate exclude sau modifica condițiile de garantare reglementate de legile statului care nu pot fi excluse sau modificate în niciun caz.

Înainte de fiecare operație, scoateți cu atenție ambalajul și verificați integritatea perfectă a produsului. Dacă se înregistrează defecțiuni sau deteriorări, nu instalați și nu încercați să reparați echipamentul! Contactați distribuitorul! Nu lăsați ambalajul la îndemâna copiilor și nu aruncați componentele acestuia decât în conformitate cu reglementările în vigoare.

1. PENTRU SIGURANTA Dvs.

- Acest produs este destinat uzului casnic și nu este adecvat pentru utilizare în medii comerciale / industriale sau pe vehicule, bărci sau aeronave.
- Aparatul poate fi utilizat de copii cu vârsta de minim 8 ani și de persoane cu capacitate fizică, senzorială și mentală redusă sau fără experiență și cunoștințe necesare, numai sub supraveghere sau după ce au fost instruiți să folosească echipamentul în siguranță și să înțeleagă pericolele inerente acestuia. Copiii nu trebuie să se joace cu aparatul. Curățarea și întreținerea necesare bunei funcționări a aparatului nu trebuie efectuate de copii fără supraveghere.
- Copiii sub 3 ani nu trebuie să se apropie de produs fără supravegherea unui adult.
- Copiii cu vârste cuprinse între 3 și 8 ani pot doar porni/opri aparatul atât timp cât acesta a fost instalat și poziționat în conformitate cu condițiile normale de utilizare și sunt supravegheați sau instruiți în mod corespunzător cu privire la utilizarea corectă și sigură a produsului și au înțeles pericolul acestuia. Copiii cu vârste cuprinse între 3 și 8 ani nu pot conecta sau programa produsul, nu îl pot curăța sau întreține.
- **ATENȚIE: Unele părți ale acestui produs pot deveni foarte fierbinți și pot cauza arderi. O atenție deosebită trebuie acordată în prezența copiilor sau a oamenilor vulnerabili.**
- Asigurați-vă că sursa de alimentare corespunde datelor de calibrare: 230V ~, 50Hz.

- Produsul are un nivel dublu de protecție împotriva apei: IPX0 când este folosit ca incalzitor mobil și IPX4 când este instalat pe perete. Respectați reglementările țării în care produsul este instalat pentru a fi utilizat în medii diferite. Când este instalat pe perete, acesta poate fi folosit în bai atata timp cat nu se afla in perimetrul vanei sau dusului. Prin urmare, produsul nu poate fi instalat în zonele indicate ca volum 1 în diagrama din figura 1. Dacă este folosit ca incalzitor mobil, asigurați-vă că convectorul nu este accesibil de la cadă, duș sau piscină.
- În timpul funcționării, așezați convectorul într-o poziție sigură, adică:
 - cel puțin la 1 m de obiecte inflamabile sau mobile
 - lăsând grilajul de evacuare a aerului liber, neacoperit
 - nu se află niciodată imediat sub o priză electrică
- Nu lăsați animalele sau copiii să se joace sau să atingă suportul convectorului. Atenție! În timpul funcționării, grilajul de evacuare a aerului poate deveni foarte fierbinte (peste 90 ° C);
- **IMPORTANT: pentru a evita supraîncălzirea, nu acoperiți niciodată produsul. Nu puneți niciodată obiecte sau păături pe aparat în timp ce acesta funcționează. Acest lucru este scris în mod clar pe dispozitiv sau ilustrat de simbolul**



- Nu utilizați convectorul în încăperi saturate cu gaze explozive, vapori generați de solvenți și lacuri sau în orice tip de vapori/gaze inflamabile.
- Dacă cablul este deteriorat și trebuie să îl înlocuiți, nu efectuați această operațiune singur. Trimiteți convectorul la un centru de reparații autorizat deoarece este necesara interventia unui personal special instruit pentru a evita orice risc de deteriorare.
- Convectorul trebuie să fie poziționat astfel încât priza sa fie intotdeauna accesibila.
- Nu instalați produsul pe pereți din material sintetic.
- Nu utilizați convectorul dacă acesta a căzut;
- Nu utilizați dacă există semne vizibile de deteriorare a convectorului;

- Utilizați convectorul pe o suprafață orizontală și stabilă;
- **ATENȚIE:** Nu utilizați convectorul în încăperi mici atunci când sunt ocupate de persoane care nu pot părăsi singure încăperea, decât dacă sunt sub supravegherea unei persoane responsabile de siguranța acestora;
- **ATENȚIE:** Pentru a reduce riscul de incendiu, păstrați țesăturile departe de orice alt material inflamabil și la cel puțin 1 m distanță de grila de evacuare a aerului.

2. MONTAJUL PE PERETE

- Montați convectorul într-o poziție orizontală cu grila de evacuare a aerului orientată în sus.
- Acest convector este cu izolație electrică dublă (clasa II), astfel încât nu este necesară conectarea la pământare.
- Acest convector trebuie instalat în conformitate cu reglementările în vigoare în țara de instalare..
- În medii umede, cum ar fi bai și bucătării, conexiunea la rețeaua de alimentare trebuie să aibă o înălțime de cel puțin 25 cm de la sol. Dispozitivele de deconectare de la rețeaua de alimentare trebuie să permită deconectarea completă în condițiile categoriei de supratensiune III.
- Aparatul trebuie instalat pe perete, respectând distanțele minime de la tavan, podea și pereții laterali indicați în figura 2. În acest scop, suportul trebuie fixat pe perete, respectând distanțele indicate în figura 3 și în tabelul de mai jos.
- Pentru a continua instalarea:
 - Scoateți suportul de pe produs;
 - Faceti 4 găuri în perete, respectând distanțele indicate în figura 3 și specificate în tabelul următor:

MODEL	A	B	C
SIRIO 5	205mm	180mm	357mm
SIRIO 10	290mm	260mm	400mm
SIRIO 15	270mm	480mm	400mm
SIRIO 20	250mm	700mm	400mm

- Fixați consola cu ajutorul dopurilor de perete și a șuruburilor corespunzătoare tipului de perete;
- Verificați dacă distanțele minime descrise anterior sunt îndeplinite;
- Apropiați produsul de suport până când cârligele inferioare ale consolei sunt introduse în sloturile de pe panou. În spate, așa cum este indicat în figura 4;
- Rotiți partea superioară a produsului spre perete până când acesta se blochează, asigurându-vă că fixați cele 2 cârlige superioare ale suportului, așa cum se arată în figura 5;
- Blocați cele două cârlige superioare ale brațului folosind șuruburile furnizate, după cum se arată în figura 6.

3. FIXAREA ROȘILOR (OPȚIONAL)

- Convectorul poate fi de asemenea utilizat ca produs mobil prin achiziționarea roților furnizate separat.
- Pentru fixarea roților:
 - verificați orientarea corectă așa cum este indicat în figura 7;
 - fixați fiecare dintre cele două suporturi cu roțile folosind șuruburile prevăzute în figura 8. Șuruburile acestea pot fi fixate manual și nu necesită utilizarea unei scule.

4. DESCRIEREA COMENZILOR

- Convectorul este echipat cu un buton pornit / oprit pe partea dreaptă. Atunci când produsul este oprit, componentele electrice interne nu vor mai funcționa.
- Următoarele comenzi sunt integrate pe partea frontală a produsului (figura 10):



Afișaj multifuncțional pentru a afișa starea de funcționare și activarea funcțiilor:

	Comfort
	Comfort - 1 °C
	Comfort - 2°C
	Eco
	Antiinghet
	Tastatura blocata
	Senzor fereastră deschisa
	Incalzire in curs



Butonul de selectare a modului de funcționare.



Buton pentru selectarea funcțiilor speciale.



Butoane de navigare din cadrul diverselor meniuri.



Buton pentru a activa sau a dezactiva starea de așteptare.

5. PORNIRE ȘI ÎNCĂLZIRE



Produsul este alimentat de la un buton electromecanic pornit / oprit. Oprirea produsului prin intermediul acestui buton face ca alimentarea plăcii electronice să fie întreruptă și timpul și ziua curentă să fie anulate. Vă recomandăm să utilizați acest întrerupător numai dacă nu utilizați produsul pentru o perioadă îndelungată de timp. Utilizați în schimb butonul ON / STAND-BY de pe panoul de control în cazul unei întreruperi scurte a utilizării produsului. În acest fel, nu veți pierde setările de ajustare introduse anterior.

Atunci când este pornit, convectorul activează ultimul mod utilizat înainte de oprire sau întreruperea alimentării. Timpul este resetat la ora 12:00 și ziua săptămânii, luni.

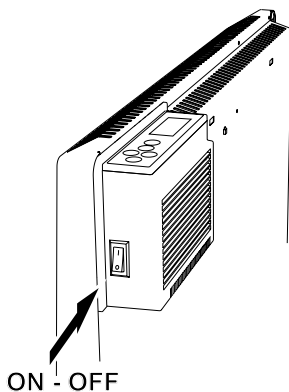

Utilizați butonul Power / Stand-by pentru a porni și opri convectorul fără a pierde timpul memorat.

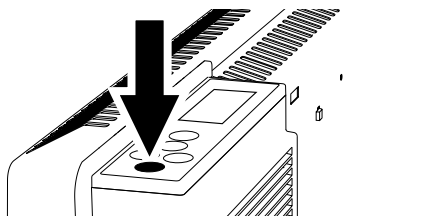

6. MOD DE OPERARE

M

Apăsând butonul  vă permite să selectați unul din următoarele 6 moduri de operare:



Mod CONFORT

Convectatorul funcționează pentru atingerea și menținerea temperaturii de confort stabile.

Simbolul corespunzător modului Comfort se aprinde.

Simbolul încălzirii se aprinde atunci când elementul de încălzire funcționează.

În acest mod, funcția de detectare a ferestrelor deschise este disponibilă (consultați butonul FUNCȚII).

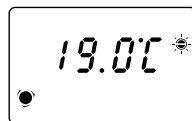

Mod CONFORT-1

Convectatorul funcționează pentru atingerea și menținerea temperaturii de confort setată, redusă cu 1 ° C.

Simbolul corespunzător modului Confort-1 se aprinde.

Simbolul încălzirii se aprinde atunci când elementul de încălzire funcționează.

În acest mod, funcția de detectare a ferestrelor deschise este disponibilă (consultați butonul FUNCȚII).

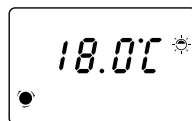

Mod CONFORT-2

Convectatorul funcționează pentru atingerea și menținerea temperaturii de confort setată, redusă cu 2 ° C.

Simbolul corespunzător modului Confort-2 se aprinde.

Simbolul încălzirii se aprinde atunci când elementul de încălzire funcționează.

În acest mod, funcția de detectare a ferestrelor deschise este disponibilă (consultați butonul FUNCȚII).

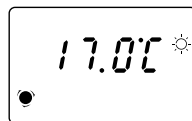

Modul ECO

Convectatorul funcționează pentru a atinge și menține temperatura de confort setată, redusă cu 3,5 ° C.

Simbolul corespunzător modului Eco se aprinde.

Simbolul încălzirii se aprinde atunci când elementul de încălzire funcționează.

În acest mod, funcția de detectare a ferestrelor deschise este disponibilă (consultați butonul FUNCȚII).

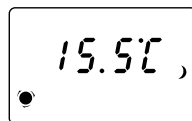

Modul ANTI-FREEZE

Termostatul este setat automat la temperatura de 7 ± 3 ° C.

Simbolul corespunzător modului antiîngheț se aprinde.

Simbolul încălzirii se aprinde atunci când elementul de încălzire funcționează.

În acest mod, funcția de detectare a ferestrelor deschise nu este disponibilă.

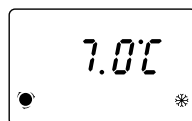

Modul PROGRAMAT

Convectatorul funcționează pentru atingerea și menținerea temperaturii setate în programul săptămânal (vezi paragraful PROGRAMARE WEEKLY).

Simbolul corespunzător modului de funcționare (Confort, Confort-1, Confort-2, Eco sau Anti-îngheț) se aprinde în funcție de setările pentru ora curentă și ziua curentă.

În acest mod, funcția de detectare a ferestrelor deschise este disponibilă (consultați butonul FUNCȚII).

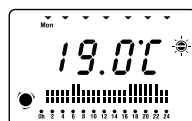

7. FUNCȚII SPECIALE

F

Apăsând butonul  vă permite să selectați una dintre următoarele 3 funcții speciale:



Funcția RESET

Prin activarea acestei funcții, toate setările sunt restaurate la valoarea inițială din fabrică. Temperatura de confort este setată la 19,0 °C, programul prestabilit este cel descris în secțiunea corespunzătoare și funcția de detectare a ferestrei deschise este dezactivată.

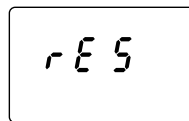

Apăsați RESET pentru cel puțin 5 secunde pentru a efectua RESET tasta .

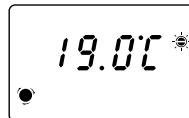

Activarea funcției de detectare a ferestrei deschise

Această funcție permite identificarea deschiderii unei ferestre și setarea automată a modului de funcționare antiîngheț.



Dacă în timpul funcționării normale a produsului este detectată o reducere bruscă a temperaturii ambiante, modul antiîngheț se activează automat pentru a reduce pierderile de energie. Simbolul ferestrei și simbolul antiîngheț indică activarea funcției. Restaurarea funcționării normale nu este automată, ci se obține prin apăsarea oricăruia dintre cele 5 taste ale produsului.

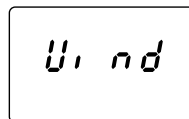

Funcționarea corectă a acestei funcții poate depinde de poziționarea produsului în cameră, de prezența curenților, de temperatura exterioară și de timpul de deschidere a ferestrei.



Activați funcția apăsând butonul  simbolul ferestrei se aprinde pe afișaj.

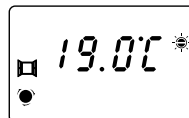

Dezactivați funcția apăsând butonul . Simbolul ferestrei se stinge.

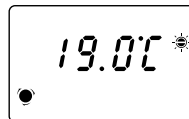



Funcția de blocare a tastaturii

Prin activarea acestei funcții, toate tastele sunt dezactivate pentru a preveni modificările nedorite ale setărilor de funcționare.

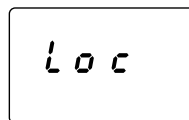

Activați funcția apăsând butonul timp de cel puțin 5 secunde. 

Simbolul cheie se aprinde pe afișaj, iar tastele sunt blocate.

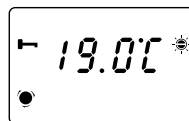

Dezactivați funcția apăsând tastele simultan timp de cel puțin 5 secunde.  

Simbolul cheie se stinge, iar tastele devin din nou active.

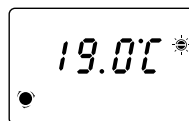

8. CONTROLUL TEMPERATURII

Controlul electronic al temperaturii se bazează pe valoarea pe care utilizatorul o atribuie temperaturii COMFORT. Valorile temperaturii pentru modurile Confort-1, Confort-2, Eco și Anti-îngheț sunt calculate automat și nu pot fi modificate direct de către utilizator. Temperatura de referință este indicată întotdeauna pe afișaj împreună cu simbolul reprezentând modul de funcționare selectat.

NOTĂ: Temperatura măsurată de senzorul din interiorul produsului indică întotdeauna temperatura ambientală în imediata vecinătate a produsului și poate fi diferită de temperatura măsurată cu alte instrumente din alte zone ale încăperii. Această diferență poate depinde de diferiți factori, cum ar fi:

- poziția de instalare: unele zone ale camerei pot fi afectate de curenți sau zone de aer cald care pot schimba măsurarea senzorului;
- Instalarea pe un perete perimetral exterior, care în mod normal este mai rece decât pereții interiori, poate duce la o temperatură mai scăzută decât temperatura reală a încăperii;
- Condiții instabile: fiecare evaluare trebuie făcută în condiții de funcționare stabile. Din acest motiv, temperatura Confort nu trebuie schimbată înainte de trecerea a 60 de minute de la modificarea anterioară. Nu este posibil să se evalueze dacă temperatura camerei este corect menținută de produs dacă nivelul de temperatură este modificat continuu într-o perioadă scurtă de timp.

Dacă diferența dintre temperatura setată și temperatura ambientală este detectată în condiții de stabilitate, calculați această diferență și apoi măriți sau micșorați nivelul temperaturii de confort pe produs a valorii diferențiale calculate exact.

9. SETAREA ZILEI SI OREI

Pentru a seta ora curentă și ziua, procedați după cum urmează:



Apăsați butonul (M) timp de cel puțin 3 secunde până cand ziua din săptămâna începe să clipească.



Apăsați butonul (M) timp de cel puțin 3 secunde până cand ziua din săptămâna începe să clipească.



Utilizați tastele (▲) ee (▼) pentru a selecta ziua curenta



Apăsați butonul (M) pentru a trece la introducerea orei curente

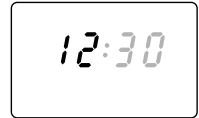

Utilizați tastele (▲) ee (▼) pentru a selecta ora curenta



Apăsați butonul (M) pentru a trece la introducerea minutelor



Utilizați tastele (▲) ee (▼) pentru a selecta minutele



Apăsați butonul (M) pentru a termina setarea și a reveni la modul Programabil.



10. PROGRAMAREA SĂPTĂMÂNALĂ

Programul săptămânal vă permite să setați modul de funcționare dorit pentru fiecare oră din zi și pentru fiecare zi a săptămânii. Convectorul este furnizat presetat cu următorul program săptămânal:

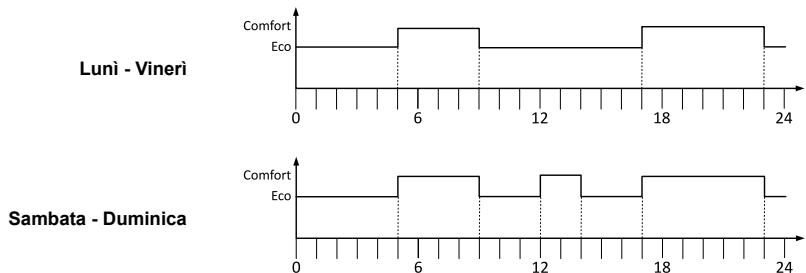

Pentru a vizualiza / modifica programul, procedați după cum urmează:



Apăsați butonul (M) până când modul de operare Programabil este activat.



Apăsați butonul (F) per almtimp de 3 secunde pentru a intra în modul de afișare / schimbare programare. On the first day of the week, the set temperature and the corresponding symbol start to flash.

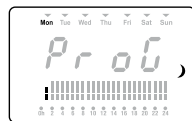

Folositi tastele (▲) si (▼) pentru a selecta diferitele ore ale zilei și tasta (M) pentru a schimba modul în care funcționează fiecare oră.



Când este apăsat butonul (M) modul de operare se modifică după secvența:



Confort > Confort-1 > Confort-2 > Eco > Anti-înghet

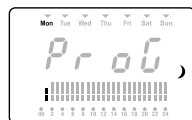

Apăsați butonul (F) pentru a comuta la vizualizarea / editarea zilei următoare.



Dacă doriți să copiați setările pentru o zi în alta (după), procedați după cum urmează:



Selectați ziua de la care doriți să copiați setările și apăsați simultan tasta (▲) si (▼). Mesajul "COPY" apare pe ecran pentru a confirma că memoria a fost salvată.

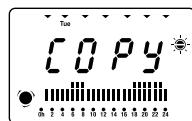

Apăsați tasta F pentru a selecta ziua pe care doriți să o programați cu același program pe care tocmai l-ați copiat.



Apăsați din nou tastele împreună (▲) si (▼) pentru a alipi programul în ziua selectată. Pe ecran apare din nou cuvântul PROG.

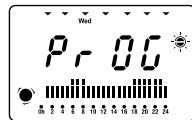

Apăsați butonul (F) pentru a comuta pentru a vizualiza / modifica ziua următoare.

Procedura se încheie prin apăsarea butonului (F) după afișarea / modificarea ultimei zile a săptămânii. Afișajul revine pentru a afișa setările de programare pentru ziua și ora curente.



11. DEPANAREA

- În cazul supraîncălzirii, dispozitivul de protecție din interiorul produsului dezactivează atât rezistența. În acest caz:
 - Opriți convectorul și lăsați-l să se răcească timp de aproximativ 15/20 minute;
 - Eliminați orice posibilă cauză de supraîncălzire (de exemplu: obstrucții la grilele de ieșire aer, reziduuri de murdărie pe produs etc.);
 - Porniți din nou convectorul și verificați dacă acesta funcționează corect.

12. ÎNTREȚINERE

- Acest produs nu necesită întreținere specială.
- Curățați produsul cu o cârpă uscată cel puțin o dată la 6 luni.
- Dacă produsul trebuie reparat, contactați un centru de service calificat.
- În cazul înlocuirii cablului de alimentare, utilizați un H05RR-F 2x0,75mm² sau 2x1,00mm² H05RRF <HAR> conform modelului de convector. Această înlocuire trebuie efectuată de personal tehnic calificat și niciodată de utilizatorul final, pentru a evita deteriorarea produsului și orice risc pentru persoană.

13. PREVEDERI LEGALE



Protecția mediului și reciclarea

Pentru ca aparatul să nu fie deteriorat în timpul transportului, a fost ambalat cu grijă. Pentru a contribui la protecția mediului nostru, vă rugăm să eliminați corespunzător materialul utilizat pentru ambalarea corectă a aparatului.

Eliminarea aparatelor uzate

Aparatele marcate cu marcajul lateral nu trebuie aruncate împreună cu deșeurile menajere, ci trebuie colectate și eliminate separat. Eliminarea echipamentelor uzate trebuie efectuată într-o manieră adecvată, în conformitate cu regulamentele și reglementările aplicabile la nivel local.

Informații obligatorii pentru încălzitoarele electrice locale

Identificator model: SIRIO					
Data	Simbol	Valoare	Unitati	Date	Unitati
Putere termica				Tipul de căldură, numai pentru încălzitoare electrice locale de stocare (indicați numai o singură opțiune)	
Putere termica nominala	P_{nom}	(*)	kW	controlul manual al sarcinii termice, cu termostat integrat	nu
Putere termica minima (indicativa)	P_{min}	(**)	kW	controlul manual al sarcinii termice cu feedback ambiental la temperatura camerei și / sau exterior	nu
Putere maxima termica continua	$P_{max,c}$	(***)	kW	control electronic al sarcinii termice cu feedback ambiental la temperatura camerei și / sau exterior	nu
Consum auxiliar de energie electrica				ventilator asistat de putere termică	nu
La putere termica nominala	$e_{l,max}$	0,000	kW	Tipul de ieșire termică / controlul temperaturii camerei (indicați doar o opțiune)	
La putere termica minima	$e_{l,min}$	0,000	kW	puterea termică monofazată fără controlul temperaturii ambientale	nu
In mod stand-by	$e_{l,SB}$	0,162	W	două sau mai multe faze manuale fără a controla temperatura camerei	nu
				cu reglarea temperaturii camerei prin intermediul termostatului mecanic	nu
				cu control electronic al temperaturii ambiante	nu
				cu control electronic al temperaturii camerei și al cronometrului zilnic	nu
				cu control electronic al temperaturii camerei și al cronometrului săptămânal	si
				Mai multe opțiuni de control (puteți selecta mai multe opțiuni)	
				controlul temperaturii camerei cu detectarea prezenței	nu
				controlul temperaturii camerei cu detectarea ferestrelor deschise	si
				cu opțiunea de control la distanță	nu
				cu control adaptiv de pornire	nu
				cu limitarea timpului de funcționare	nu
				cu termometru cu glob negru	nu
Contactati-ne	Distribuitorul sau Ermete Giudici S.p.A. - via L. da Vinci, 27 - 20090 Segrate (MI) Italy				

(*)	SIRIO 5 = 0,50	SIRIO 10 = 1,00	SIRIO 15 = 1,50	SIRIO 20 = 2,00
(**)	SIRIO 5 = 0,25	SIRIO 10 = 0,50	SIRIO 15 = 0,75	SIRIO 20 = 1,00
(***)	SIRIO 5 = 0,50	SIRIO 10 = 1,00	SIRIO 15 = 1,50	SIRIO 20 = 2,00

Przed uruchomieniem grzejnika należy dokładnie zapoznać się z poniższymi instrukcjami, aby uniknąć uszkodzeń i niebezpiecznych sytuacji. Jakiegokolwiek użycie grzejnika inne niż określone w niniejszej instrukcji obsługi może spowodować pożar, porażenie prądem elektrycznym lub obrażenia i utratę gwarancji.

Gwarancja nie obejmuje wad, pogorszenia, utraty, uszkodzenia lub szkody spowodowane przez lub w wyniku nieodpowiedniego użycia lub nadużycia tego grzejnika. Prawa dyktowane przez prawo państwowe nie są pomijane. Żaden z warunków niniejszej gwarancji nie wyłącza jakichkolwiek warunków bądź gwarancji przewidzianych przepisami prawa krajowego, które nie mogą zostać uchylone ani zmienione.

Przed rozpoczęciem użytkowania usunąć opakowanie i sprawdzić integralność produktu. W przypadku wad lub uszkodzeń, nie próbuj naprawiać go samodzielnie, lecz skontaktuj się z sprzedawcą.

Nie pozwalaj dzieciom bawić się opakowaniem i chronić środowisko poprzez utylizację opakowania zgodnie z krajowymi przepisami dotyczącymi przetwarzania odpadów.

1. DLA WŁASNEGO BEZPIECZEŃSTWA

- Ten grzejnik jest przeznaczony do użytku domowego i nie został przystosowany do użytku komercyjnego/przemysłowego, w samochodach, na statkach lub samolotach.
- Produkt może być stosowany przez dzieci od 8 roku życia oraz osoby o ograniczonych zdolnościach fizycznych, czuciowych lub umysłowych, lub z niedostatecznym doświadczeniem i wiedzą, pod warunkiem że są one pod nadzorem osoby odpowiedzialnej za ich bezpieczeństwo lub zostały odpowiednio poinstruowane. Dzieci nie powinny bawić się produktem. Czyszczeniem i przeglądami użytkownika nie powinny się zajmować dzieci bez nadzoru.
- Dzieci poniżej 3 roku życia powinny być trzymane z dala od urządzenia chyba że są pod stałą opieką.
- Dzieci pomiędzy 3 a 8 rokiem życia powinny tylko włączać i wyłączać urządzenie, oczywiście tylko wtedy, gdy umiejscowienie grzejnika nato pozwala, nie zapominając o ciągłym nadzorze i wytłumaczeniu jak korzystać z urządzenia w bezpieczny sposób. Dzieci pomiędzy 3 a 8 rokiem życia nie powinny wyciągać wtyczki z gniazda, operować termostatem, czyścić grzejnik lub wykonywać kontrole użytkownika urządzenia.
- **UWAGA – Niektóre elementy tego produktu mogą być bardzo gorące i mogą spowodować oparzenia. Szczególną uwagę trzeba poświęcić gdy w pobliżu znajdują się dzieci i osoby starsze.**

- Upewnij się, że zasilanie sieciowe odpowiada nominalnej mocy: 230VAC, 50Hz.
- Ten konwektor ma podwójny poziom ochrony przed wodą: IPX0, gdy jest używany jako przenośny, a IPX4 kiedy zamontujemy go naścianie. Należy przestrzegać przepisów danego kraju sposobu i miejsca montażu w różnych pomieszczeniach. Z tego powodu może być stosowany w łazienkach lub w innych pomieszczeniach narażonych na wilgoć POD WARUNKIEM ŻE ZNAJDUJE SIĘ W BEZPIECZNEJ ODLEGŁOŚCI OD WANNY CZY PRYSZNICA. Oznacza to, że nie można go instalować w obszarach oznaczonych jako VOLUME 1 na rysunku 1. W przypadku używania jak urządzenia przenośnego nie należy używać tego grzejnika w najbliższym otoczeniu wanny, pryszniczicy lub basenu;
- Podczas działania ustawić konwektor w bezpiecznej pozycji:
 - co najmniej 1m od łatwopalnych przedmiotów lub mebli;
 - pozostawiając nie mniej niż 1m wolnej przestrzeni przed konwektorem;
 - nie znajduje się bezpośrednio pod gniazdem.
- Grzejnika nie wolno pozostawiać do zabawy dzieciom ani nie wolno dopuścić, aby zwierzęta dotykały jego powierzchni. Zwróć uwagę! Kratka wylotu powietrza nagrzewa się podczas pracy urządzenia (do ponad 90 °C)
- **UWAGA: Aby uniknąć przegrzania, nie należy przykrywać grzejnika.** Nie zawieszaj niczego na grzejniku i nie zakrywaj go podczas pracy. Jest to wyraźnie napisane na okładce produktu lub oznaczone symbolem:



- Nie używaj grzejnika w pomieszczeniach z gazem wybuchowym lub podczas korzystania z łatwopalnych rozpuszczalników, lakierów lub klejów.
- Jeśli przewód jest uszkodzony i trzeba go wymienić, nie rób tego sam! Dostarcz produkt do autoryzowanego centrum napraw lub do osoby o podobnych umiejętnościach i wiedzy, w celu uniknięcia ryzyka uszkodzenia.
- Urządzenie musi być zamontowane tak, aby wtyczka była

zawszedostępna.

- Nie należy montować urządzenia na ścianach wykonanych z materiałów syntetycznych.
- Nie używaj tego grzejnika, jeśli został upuszczony;
- Nie używać, jeśli widoczne są oznaki uszkodzenia grzejnika;
- Używaj tego grzejnika na poziomej i stabilnej powierzchni;
- UWAGA: Nie używaj tego grzejnika w małych pomieszczeniach, gdyś one zajęte przez osoby, które nie mogą opuścić pomieszczenia samodzielnie, chyba że zapewniony jest stały nadzór.
- UWAGA: Aby zmniejszyć ryzyko pożaru, tkaniny, zasłony lub inne łatwopalne materiały należy przechowywać w odległości co najmniej 1m od wylotu powietrza.

2. MONTAŻ NA ŚCIANIE

- Przymocuj konwektor w pozycji poziomej, z kratką wylotu powietrza skierowaną do góry;
- Konwektor jest wyposażony w podwójny obwód izolacji elektrycznej (klasa II) i w związku z tym nie wymaga uziemienia;
- Sposób montażu grzejnika musi być zgodny z wymaganiami określonymi w obowiązujących przepisach krajowych.
- W pomieszczeniach wilgotnych, takich jak łazienki czy kuchnie, przyłączy elektryczne należy zamontować na wysokości co najmniej 25 cm powyżej poziomu podłogi. Ponadto, sieć zasilającą, do której ma zostać podłączone urządzenie, należy wyposażyć w wyłącznik dwubiegunowy zapewniający minimalną odległość między stykami. Takie rozwiązanie pozwoli na całkowite odłączenie urządzenia w warunkach określonych zgodnie z III kategorią przepięciową.
- Urządzenie musi być zamontowane na ścianie z zachowaniem minimalnych odległości od sufitu, podłogi i ścian bocznych pokazanych na rys. 2. Wspornik montażowy musi być przymocowany do ściany zgodnie z odległościami wskazanymi na rysunku 3 i podanymi w poniższej tabeli. Zawsze przestrzegaj minimalnych odległości od ścian, mebli i / lub przedmiotów, jak pokazano na rysunku 3.
- Aby kontynuować montaż:
 - Usuń wspornik z produktu;
 - Wywierć 4 otwory w ścianie zgodnie z odległościami wskazanymi na rysunku 3 i określonymi w tabeli poniżej:

MODEL	A	B	C
SIRIO 5	205mm	180mm	357mm
SIRIO 10	290mm	260mm	400mm
SIRIO 15	270mm	480mm	400mm
SIRIO 20	250mm	700mm	400mm

- Przymocuj wspornik za pomocą kołków i śrub odpowiednich do rodzaju ściany;
- Upewnij się, że opisane powyżej minimalne odległości są zachowane;
- Zbliż produkt do wspornika, aż dolne zaczepy wspornika zostaną włożone w dolne otwory z tyłu grzejnika, jak pokazano na rysunku 4;
- Obróć górną część produktu w kierunku ściany, aż się zablokuje, upewniając się, aby zatrasnąć 2 górne zaczepy wspornika, jak pokazano na rysunku 5;
- Zablokuj 2 górne zaczepy wspornika za pomocą dostarczonych śrub, jak pokazano na rysunku 6.

3. MONTAŻ KÓŁEK (OPCJONALNIE)

- Konwektor można również wykorzystać jako produkt przenośny, dokonując zakupu kół, które są dostarczane osobno.
- Aby zamontować koła:
 - sprawdź poprawną pozycję grzejnika, jak pokazano na rysunku 7.
 - Zamocuj każdą z 2 podpór za pomocą dostarczonych śrub, jak pokazano na rysunku 8. Śruby można zamocować ręcznie i nie wymagają żadnego narzędzia.

4. KORZYSTANIE Z PRODUKTU

- Konwektor jest wyposażony w przycisk włączania / wyłączania po prawej stronie. Gdy produkt jest wyłączony, wewnętrzne komponenty elektryczne nie będą zasilane.
- Od góry urządzenia zintegrowano następujące elementy sterujące (rysunek 10):



Wyświetlacz wielofunkcyjny do przeglądania stanu działania i aktywacji funkcji.

	Komfort
	Komfort - 1 °C
	Komfort - 2°C
	Eco
	Przeciw-zamrożeniowy
	Blokada klawiatury
	Czujnik otwartego okna
	W trakcie ogrzewania



Przycisk wyboru trybu pracy.



Przycisk funkcji specjalnych.



Przyciski nawigacyjne.



Włącz/wyłącz przycisk Zasilanie/Czuwanie.

5. WŁĄCZANIE/WYŁĄCZANIE



Produkt jest zasilany przez elektromechaniczny przycisk włączania / wyłączenia. Po wyłączeniu tego przełącznika następuje wyłączenie zasilania termostatu oraz anulowanie bieżącej godziny i dnia. Zalecamy używanie go tylko wtedy, gdy nie używasz go przez dłuższy czas, a zamiast tego użyj przycisku Zasilanie / Czuwanie na panelu sterowania w przypadku krótkiej przerwy w działaniu urządzenia. W ten sposób nie utracisz wcześniej wprowadzonych ustawień. Po włączeniu konwektor aktywuje ostatni tryb używany przed wyłączeniem lub awarią zasilania. Czas resetuje się na godzinę 12:00 oraz dzień tygodnia na poniedziałek.

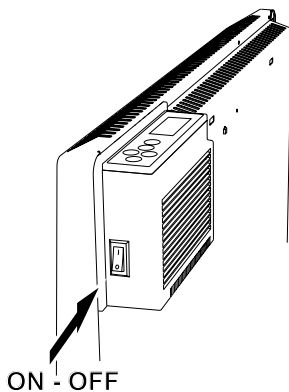

Użyj przycisku Zasilanie / Czuwanie, aby włączyć i wyłączyć konwektor bez utraty wprowadzonych ustawień.

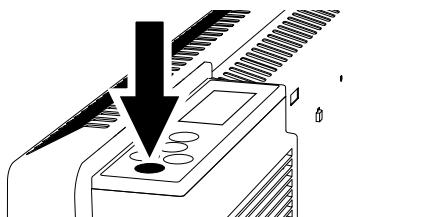

6. TRYBY PRACY

M

Po naciśnięciu przycisku  można wybrać jeden z 6 następujących trybów pracy:



Tryb KOMFORT

Konwektor działa, aby osiągnąć i utrzymać ustawioną temperaturę komfortową.

Symbol odpowiadający trybowi Komfort pojawi się na wyświetlaczu. Symbol grzania świeci się, gdy element grzewczy działa. W tym trybie dostępna jest funkcja wykrywania otwartego okna (patrz przycisk FUNKCJE).

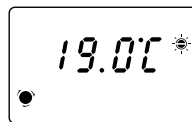

Tryb KOMFORT -1

Konwektor działa, aby osiągnąć i utrzymać ustawioną temperaturę komfortową zmniejszoną o 1° C.

Symbol odpowiadający trybowi Komfort pojawi się na wyświetlaczu. Symbol grzania świeci się, gdy element grzewczy działa. W tym trybie dostępna jest funkcja wykrywania otwartego okna (patrz przycisk FUNKCJE).

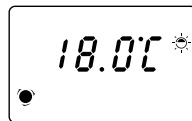

Tryb KOMFORT -2

Konwektor działa, aby osiągnąć i utrzymać ustawioną temperaturę komfortową zmniejszoną o 2° C.

Symbol odpowiadający trybowi Komfort pojawi się na wyświetlaczu. Symbol grzania świeci się, gdy element grzewczy działa. W tym trybie dostępna jest funkcja wykrywania otwartego okna (patrz przycisk FUNKCJE).

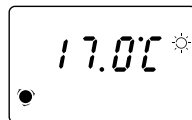

Tryb ECO

Konwektor działa, aby osiągnąć i utrzymać ustawioną temperaturę komfortową zmniejszoną o 3.5° C.

Symbol odpowiadający trybowi Eco pojawi się na wyświetlaczu. Symbol grzania świeci się, gdy element grzewczy działa. W tym trybie dostępna jest funkcja wykrywania otwartego okna (patrz przycisk FUNKCJE).

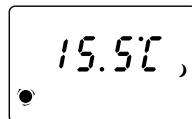

Tryb Przeciw-zamrożeniowy

Termostat jest automatycznie ustawiany na temperaturę 7±3 ° C. Symbol odpowiadający trybowi przeciw zamarzaniu pojawi się na wyświetlaczu.

Symbol grzania świeci się, gdy element grzewczy działa. W tym trybie funkcja wykrywania otwartego okna nie jest dostępna.

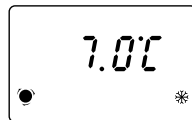

Tryb programu

Konwektor pracuje, aby osiągnąć i utrzymać temperaturę ustawioną w programie tygodniowym (patrz akapit dotyczący PROGRAMOWANIA TYGODNIOWEGO). Symbol odpowiadający trybowi pracy (tryb Komfort, Komfort-1, Komfort-2, Eco lub przeciw-zamrożeniowy) pojawi się na wyświetlaczu zgodnie z ustawieniami dla bieżącej godziny i dnia. W tym trybie dostępna jest funkcja wykrywania otwartego okna (patrz przycisk FUNKCJE).



7. FUNKCJE SPECJALNE

F

Po naciśnięciu przycisku  można wybrać jedną z 3 następujących funkcji specjalnych:



Funkcja RESET

Po aktywowaniu tej funkcji wszystkie ustawienia zostają przywrócone do początkowej wartości fabrycznej. Temperatura komfortowa jest ustawiona na 19,0 °C, nastawiony program (opisany w odpowiedniej sekcji) oraz funkcja wykrywania otwartego okna są dezaktywowane.

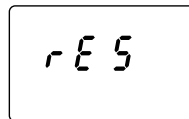

5" Aby zresetować przytrzymaj przycisk  przez 5 sekund.

Konwektor jest automatycznie ustawiany w trybie Komfort.

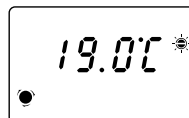

Funkcja wykrywania otwartego okna

Ta funkcja pozwala zidentyfikować otwarcie okna i automatycznie ustawić tryb pracy przeciw-zamrożeniowy.



Jeżeli podczas normalnej pracy urządzenia zostanie wykryty nagły spadek temperatury otoczenia, tryb przeciw zamarzaniu włącza się automatycznie w celu zmniejszenia strat energii. Symbol okna i symbol przeciw zamarzaniu migają, wskazując, że funkcja jest aktywna.

Przywrócenie normalnej pracy nie jest automatyczne, ale uzyskuje się je poprzez naciśnięcie dowolnego z 5 przycisków produktu.

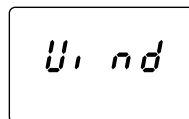



Prawidłowe działanie tej funkcji może zależeć od umiejscowienia produktu w pomieszczeniu, obecności przeciągów, temperatury zewnętrznej i czasu otwarcia okna.

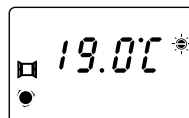

Aktywuj funkcję naciskając przycisk .

Symbol okna zaświeci się na wyświetlaczu.



Dezaktywuj funkcję naciskając przycisk .

Symbol okna wyłączy się na wyświetlaczu.

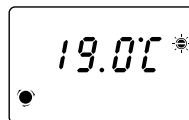



Funkcja blokady klawiatury

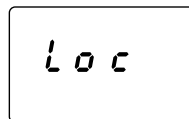

Po uaktywnieniu tej funkcji wszystkie klawisze zostają dezaktywowane, aby zapobiec niechcianej modyfikacji ustawień.

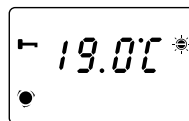

Aktywuj funkcję przytrzymując przycisk  5 sekund.

Na wyświetlaczu pojawia się symbol klucza, a klawisze zostaną zablokowane.



Dezaktywuj funkcję przytrzymując przyciski  i  jednocześnie przez co najmniej 5 sekund.

Symbol klucza wyłącza się, przyciski działają ponownie.

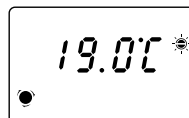

8. KONTROLA TEMPERATURY

Elektroniczna kontrola temperatury opiera się na wartości, którą użytkownik przypisuje do temperatury KOMFORT. Wartości temperatur dla trybów Komfort-1, Komfort-2, Eco i przeciw-zamrożeniowa są obliczane automatycznie i niemogą być bezpośrednio modyfikowane przez użytkownika. Zadana temperatura jest zawsze wskazywana na wyświetlaczu razem z symbolem przedstawiającym wybrany tryb pracy. UWAGA: Temperatura mierzona przez czujnik wewnątrz produktu zawsze wskazuje temperaturę otoczenia w bezpośrednim sąsiedztwie produktu i może różnić się od temperatury zmierzonej za pomocą innych przyrządów pomiarowych w innych częściach pomieszczenia. Ta różnica może zależeć od różnych czynników, takich jak:

- Miejsce instalacji: na niektóre obszary pomieszczenia mogą wpływać prądy ciepłego powietrza, które mogą zmienić pomiar czujnika;
- Instalacja na zewnętrznej ścianie, która jest zwykle zimniejsza niż ściany wewnętrzne, może powodować niższy pomiar temperatury niż rzeczywista temperatura pomieszczenia;
- Niestabilne warunki: każdą ocenę należy przeprowadzić w stabilnych warunkach pracy. Z tego powodu temperatura komfortu nie powinna być zmieniana przed upływem 60 minut od poprzedniej modyfikacji. W rzeczywistości nie można ocenić, czy temperatura w pomieszczeniu jest prawidłowo utrzymywana przez produkt, jeśli poziom temperatury jest stale modyfikowany w krótkim okresie czasu. Jeśli różnica między temperaturą zadaną a temperaturą otoczenia zostanie wykryta w warunkach stabilnych, należy obliczyć tę różnicę, następnie zwiększyć lub zmniejszyć poziom temperatury komfortu na produkcie o dokładnie obliczoną wartość różnicy.

9. USTAWIENIE DATY I CZASU

Aby ustawić aktualną godzinę i datę, wykonaj następujące czynności:



Naciskaj przycisk **(M)**, aż wybrany zostanie tryb programu.



Przytrzymaj przycisk **(M)** przez 3 sekundy dopóki nie zacznie migać dzień tygodnia.



Użyj przycisków **(▲)** i **(▼)** aby ustawić aktualną datę.



Naciśnij przycisk **(M)** aby przełączyć między ustawieniem dnia a ustawieniem czasu.



Użyj przycisków **(▲)** i **(▼)** aby wybrać aktualny czas.



Naciśnij przycisk **(M)** aby przełączyć między ustawieniem godzin i minut.

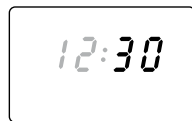

Użyj przycisków **(▲)** i **(▼)** aby ustawić bieżące minuty.



Naciśnij przycisk **(M)** aby zakończyć ustawienie i powrócić do trybu programu.



10. PROGRAMOWANIE TYGODNIOWE

Tygodniowe programowanie pozwala ustawić żądany tryb pracy dla każdej godziny i dnia tygodnia. Konwektor dostarczany jest z ustawionym programem tygodniowym:

Poniedziałek - Piątek

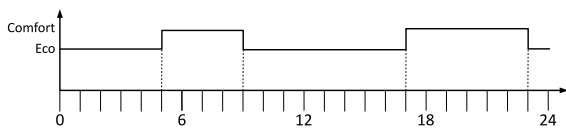

Sobota - Niedziela

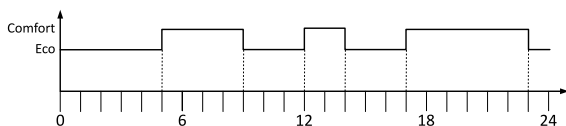

Aby wyświetlić / zmodyfikować program, wykonaj następujące czynności:



Naciskaj przycisk **M** aż uaktywni się zaprogramowany tryb pracy.



Przytrzymaj przycisk **F** przez co najmniej 3 sekundy, aby przejść do widoku / edycji trybu programowania. W pierwszy dzień tygodnia, ustawiona temperatura i odpowiedni symbol zaczną migać.

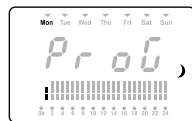

Użyj przycisków  i  aby ustawić różne pory dnia i przycisk **M** aby zmienić tryb pracy każdej godziny.



Z każdym naciśnięciem przycisku **M** tryb pracy zmienia się w następującej sekwencji:



Komfort > Komfort-1 > Komfort-2 > Eco >Przeciw-zamrożeniowy

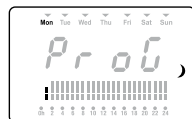



Naciśnij przycisk **F** aby wyświetlić / edytować następny dzień.



Jeśli chcesz skopiować ustawienia z jednego dnia do drugiego (kolejno), wykonaj następujące czynności:



Wybierz dzień, w którym chcesz skopiować ustawienia, a następnie naciśnij przyciski  i  jednocześnie. Na wyświetlaczu pojawi się słowo "COPY" potwierdzające, że zostało zapisane.

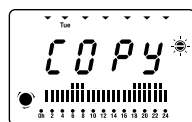

Naciśnij przycisk **F**, aby wybrać dzień, który chcesz zaprogramować za pomocą tego samego skopiowanego programu.



Naciśnij ponownie przyciski  i  jednocześnie aby wkleić program w wybranym dniu. Na wyświetlaczu pojawi się słowo PROG.



Naciśnij przycisk **F** aby wyświetlić / edytować następny dzień. Procedura kończy się po ponownym naciśnięciu przycisku po obejrzeniu / edycji ostatniego dnia tygodnia. Na wyświetlaczu pojawi się ustawienie programu dla bieżącego dnia i godziny.



11. WRAZIE PROBLEMÓW

- W przypadku przegrzania urządzenie zabezpieczające na urządzeniu automatycznie wyłączy element grzewczy. W takim przypadku należy:
 - Wyłączyć konwektor i pozwolić mu ostygnąć przez około 15/20 minut.
 - Wyeliminować wszelkie inne możliwe przyczyny przegrzania (np. Przeszkody przed kratkami wlotu /wylotu powietrza, gromadzenie się brudu).
 - Włączyć konwektor ponownie i sprawdzić, czy działa poprawnie.

12. KONSERWACJA

- Ten produkt nie wymaga specjalnej konserwacji.
- Czyszczenie produktu za pomocą suchej szmatki raz na 6 miesięcy.
- Jeśli produkt wymaga naprawy, należy skontaktować się z autoryzowanym serwisem technicznym.
- W przypadku wymiany kabla zasilającego, użyj 2x0,75mm² H05RR-F lub 2x1,00 mm² Typu H05RR-F <HAR>Czynności te muszą być wykonywane przez wykwalifikowany personel, a nie przez użytkownika końcowego, aby uniknąć uszkodzenia urządzenia oraz zagrożenia bezpieczeństwa osobistego.

13. INFORMACJA PRAWNA



Środowisko i recykling

Aby uniknąć uszkodzeń podczas transportu, urządzenie zostało starannie zapakowane. Aby przyczynić się do ochrony naszego środowiska, prosimy o prawidłowe pozbywanie się materiałów opakowaniowych.

Recykling przestarzałych urządzeń

Urządzenia z tą etykietą nie mogą być utylizowane wraz z odpadami ogólnymi, ale należy je zbierać i usuwać osobno. Usuwanie zużytych urządzeń musi odbywać się z dużą dokładnością, zgodnie z lokalnie obowiązującymi przepisami.

Informacje wymagane dla lokalnych elektrycznych ogrzewaczy pomieszczeń

Model: SIRIO					
Opis	Symbol	Wartość	Jednostka	Opis	
Moc grzewcza				Rodzaj wejścia ciepła, dla elektrycznych miejscowych ogrzewaczy pomieszczeń (wybierz jeden)	
Nominalna moc grzewcza	P_{nom}	(*)	kW	Ręczna regulacja ładowania ciepła, z wbudowanym termostatem	nie
Minimalna moc grzewcza(orientacyjny)	P_{min}	(**)	kW	Ręczna regulacja ładowania ciepła z odczytem temperatury pokojowej i/lub temperatury zewnętrznej	nie
Maksymalna ciągła moc grzewcza	$P_{max,c}$	(***)	kW	Elektroniczna regulacja ładowania ciepła z odczytem temperatury pokojowej i/lub temperatury zewnętrznej	nie
Dodatkowe zużycie energii elektrycznej				Ciepło wspomagane wentylatorem	nie
Przy nominalnej mocy grzewczej	eI_{max}	0,000	kW	Rodzaj mocy grzewczej/kontroli temperatury pokojowej (wybierz jedną)	
Przy minimalnej mocy grzewczej	eI_{min}	0,000	kW	Jednostopniowe wytwarzanie ciepła i brak kontroli temperatury w pomieszczeniu	nie
W trybie czuwania(standby)	eI_{SB}	0,162	W	Dwa lub więcej ręcznych etapów, brak kontroli temperatury w pomieszczeniu	nie
				Z ręczną regulacją temperatury pomieszczenia	nie
				Z elektroniczną regulacją temperatury pomieszczenia	nie
				Elektroniczna regulacja temperatury w pomieszczeniu plus zegar dzienny	nie
				Elektroniczna regulacja temperatury w pomieszczeniu plus zegar tygodniowy	tak
				Inne opcje sterowania (możliwe wielokrotne wybory)	
				Kontrola temperatury w pomieszczeniu, z wykrywaniem obecności	nie
				Kontrola temperatury w pomieszczeniu, z wykrywaniem otwartego okna	tak
				Z opcją kontroli odległości	nie
				Z adaptacyjną kontrolą startu	nie
				Z ograniczeniem czasu pracy	nie
				Z czujnikiem black bulb	nie
Dane producenta	Twój sprzedawca lub Ermete Giudici S.p.A. - via L. da Vinci, 27 - 20090 Segrate (MI) Italy				

(*)	SIRIO 5 = 0,50	SIRIO 10 = 1,00	SIRIO 15 = 1,50	SIRIO 20 = 2,00
(**)	SIRIO 5 = 0,25	SIRIO 10 = 0,50	SIRIO 15 = 0,75	SIRIO 20 = 1,00
(***)	SIRIO 5 = 0,50	SIRIO 10 = 1,00	SIRIO 15 = 1,50	SIRIO 20 = 2,00

Lees deze instructies zorgvuldig door voordat u de convector gebruikt. Zo voorkomt u schade en gevaarlijke situaties. Enig gebruik anders dan beschreven in deze handleiding kan brand, elektrische schokken of letsel veroorzaken en leidt ertoe dat de garantie vervalt.

De garantie geldt niet voor eventuele defecten, verslechtering, verlies, letsel of schade veroorzaakt door of als gevolg van het verkeerd gebruik of misbruik van deze radiator. Aan rechten die voortvloeien uit nationale wetgeving wordt geen afbreuk gedaan. Geen van de garantiebepalingen vormt een uitsluiting van voorwaarden of garanties vastgelegd in nationale wetgeving, die niet uitgesloten of gewijzigd kunnen worden.

Verwijder vóór het gebruik de verpakking en controleer of het apparaat intact is. Neem in geval van defecten of schade contact op met de dealer. Probeer het apparaat niet zelf te repareren.

Laat kinderen niet met de verpakking spelen en bescherm het milieu door de verpakking overeenkomstig de nationale voorschriften voor afvalverwerking te verwijderen.

1. VOOR UW VEILIGHEID

- Dit apparaat is bedoeld voor normaal huishoudelijk gebruik en niet voor gebruik in commerciële/industriële omgevingen, in voertuigen of aan boord van schepen of vliegtuigen.
- - Dit apparaat kan worden gebruikt door kinderen vanaf 8 jaar en personen met verminderde lichamelijke, zintuiglijke of verstandelijke vermogens of een gebrek aan ervaring en kennis, mits ze onder toezicht staan of instructies hebben gekregen over hoe ze het apparaat op een veilige manier kunnen gebruiken en de risico's begrijpen. Kinderen mogen niet met het apparaat spelen. Reiniging of onderhoud mag niet door kinderen worden uitgevoerd, tenzij onder toezicht.
- Het gebruik van water is strikt verboden.
- Kinderen jonger dan 3 jaar moeten uit de buurt van het apparaat worden gehouden, tenzij er voortdurend toezicht is.
- Kinderen tussen de 3 en 8 jaar mogen het apparaat alleen in-/uitschakelen indien het op de beoogde, normale plek van gebruik is geplaatst of geïnstalleerd, mits ze onder toezicht staan of instructies hebben gekregen over hoe ze het apparaat op een veilige manier kunnen gebruiken en de risico's begrijpen. Kinderen tussen de 3 en 8 jaar mogen het apparaat niet aansluiten, regelen of schoonmaken, of onderhoud eraan plegen.
- **LET OP: Sommige delen van dit apparaat kunnen zeer heet worden en brandwonden veroorzaken. Let vooral op wanneer kinderen en kwetsbare personen aanwezig zijn.**

- Zorg ervoor dat de netvoeding overeenkomt met de nominale voedingsspanning: 230 V AC, 50 Hz
- Deze convector heeft classificatie IPX4. Houd u zich aan de plaatselijk geldende voorschriften betreft de plaatsingsmogelijkheden in verschillende ruimtes. De convector kan in vochtige ruimtes worden toegepast, zie voor de plaatsingsmogelijkheid in vochtige ruimtes afbeelding 1. Dit betekent dat de convector in zone 2 gemonteerd mag worden, elektrische aansluiting in zone 3. Plaats de convector niet in de omgeving van zwembaden.
- Plaats de convector op een veilige plaats:
 - houd minstens 1m afstand van ontvlambare objecten (textiel, gordijnen of andere ontvlambare materialen) om het risico op brand te verminderen.
 - 1 meter vrije ruimte voor de convector.
- Laat kinderen niet met de convector spelen en zorg ervoor dat kinderen en dieren het niet aanraken. Let op! Het paneel kan tijdens gebruik zeer heet worden (circa 90 °C);
- **WAARSCHUWING: Om oververhitting te voorkomen mag de convector niet worden afgedekt.** Hang niets over de convector en dek het niet af terwijl deze in bedrijf is (zie afbeelding 9). Dit zoals aangegeven op het bedieningspaneel van de convector met het symbool:



- Gebruik de convector niet in ruimtes met explosieve gassen, dampen van oplosmiddelen of verf, of ontvlambare dampen/gassen.
- Repareer een beschadigde kabel en/of stekker niet zelf, maar breng de convector naar de technische dienst of een erkend reparatiecentrum en laat het repareren door gespecialiseerd personeel om het risico op beschadiging te voorkomen.
- Plaats de convector zodanig dat de stekker altijd bereikbaar is.
- De convector mag niet direct onder een stopcontact worden geplaatst.
- Steek geen objecten of papier in de convector.
- Monteer het product niet op wanden van kunststof.
- Gebruik deze convector niet als deze is gevallen;

- Niet gebruiken als er zichtbare tekenen van schade aan de kachel zijn;
- Gebruik deze convector op een horizontaal en stabiel oppervlak;
- **WAARSCHUWING:** Gebruik deze convector niet in kleine ruimtes wanneer deze worden gebruikt door personen die niet in staat zijn de kamer zelfstandig te verlaten, tenzij constant toezicht wordt geboden.
- **WAARSCHUWING:** om brandgevaar te verminderen houdt textiel, gordijnen of andere ontvlambare producten minimaal op 1 meter afstand van de warme lucht uitlaat.

2. MONTAGE

- Bevestig de convector in horizontale positie met het luchtuitlaatrooster naar boven gericht;
- De convector heeft een dubbele elektrische isolatie (klasse II) en heeft daarom geen aarding nodig;
- Deze convector moet worden geïnstalleerd in overeenstemming met de geldende voorschriften die van kracht zijn in het land van installatie.
- Installeer de aansluitdoos in badkamers, keukens of andere vochtige ruimtes ten minste 25 cm boven de vloer.
- - De elektrische aansluiting op de netvoeding moet tevens een 2-polige schakelaar met een minimale contactopening van 3 mm omvatten. Leef altijd de nationale bekabelingsvoorschriften na en houd u aan de plaatsingsvoorschriften (zie afbeelding 1).
- - De convector moet aan de muur worden gemonteerd met inachtneming van de minimumafstanden van het plafond, de vloer en de zijwanden zoals weergegeven in figuur 2. De wandbeugel moet aan de muur worden bevestigd met inachtneming van de afstanden, aangegeven in figuur 3 en gespecificeerd in de volgende tabel.
- Houd altijd rekening met de minimale afstanden tot muren, meubels en/of objecten, zoals aangegeven op afbeelding 3.
- Installeren convector:
 - Verwijder de beugel van de convector;
 - Boor 4 gaten in de muur met inachtneming van de afstanden aangegeven in figuur 3 en gespecificeerd in de volgende tabel:

MODEL	A	B	C
SIRIO 5	205mm	180mm	357mm
SIRIO 10	290mm	260mm	400mm
SIRIO 15	270mm	480mm	400mm
SIRIO 20	250mm	700mm	400mm

- Bevestig de muurbeugel met behulp van muurpluggen en schroeven die geschikt zijn voor het muurtype;
- Controleer of aan de eerder beschreven minimumafstanden is voldaan;
- Breng de convector naar de beugel totdat de onderste haken van de beugel in de sleuven op het achterpaneel zijn gestoken, zoals weergegeven in afbeelding 4;
- Draai het bovenste deel van het product naar de muur totdat het vastklikt in de 2 bovenste haken, zoals weergegeven in afbeelding 5;
- Vergrendel de 2 bovenste haken van de beugel met behulp van de meegeleverde schroeven, zoals weergegeven in figuur 6.

3. WIELBEVESTIGING (OPTIONEEL)

- De convector kan ook worden gebruikt als een verplaatsbaar product door de afzonderlijk geleverde wielen te kopen.
- Bevestigen van de wielen:
 - controleer de juiste richting zoals weergegeven in figuur 7;
 - bevestig de 2 steunen met de wielen met behulp van de meegeleverde schroeven, zoals weergegeven in figuur 8. De schroeven kunnen met de hand worden bevestigd en vereisen geen gereedschap.

4. BESCHRIJVING BEDIENING

- De convector is uitgerust met een aan/uit schakelaar aan de rechterkant. Als de convector is uitgeschakeld, staan de interne elektrische componenten niet meer onder spanning.
- De volgende bedieningstoetsen zijn aan de rechter bovenzijde van het product geïntegreerd (afbeelding 10):



Multifunctioneel display om de werking en activeringsstatus van de functies te bekijken.

	Comfort
	Comfort - 1 °C
	Comfort - 2°C
	Eco -3,5°C
	Antivorst
	Toetsenblokkering
	Open raam-sensor
	Verwarming aan



Bedrijfsmodus.



Speciale functies.



Navigatie knoppen.



Stand-by modus aan/uit

5. IN – UIT SCHAKELEN



De convector kan worden aan/uit gezet door de aan/uit schakelaar aan de rechter zijkant. Als de convector wordt uitgeschakeld middels deze schakelaar, wordt de stroomtoevoer onderbroken en vervalt de huidige tijd en dag. We raden u aan deze aan/uit schakelaar alleen te gebruiken als u de convector gedurende langere tijd niet gebruikt.

Wanneer de convector wordt ingeschakeld (met de aan/uit schakelaar aan de zijkant of activeren van de stroomtoevoer), activeert de convector de laatste modus die werd gebruikt voor het uitschakelen of bij stroomuitval. De tijd wordt gereset op 12:00 uur en de dag van de week op maandag.

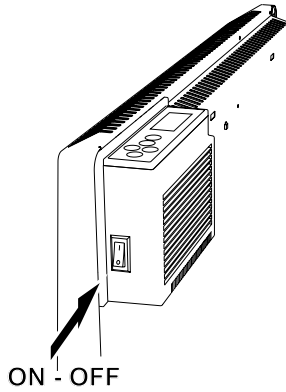

Gebruik de aan/uit Stand-by knop op het bedieningspaneel om de convector in of uit te schakelen zonder de opgeslagen tijd en dag te verliezen. Display geeft huidige dag en tijd, na het inschakelen gaat de convector in comfort modus.

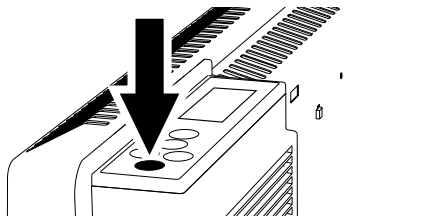

6. BEDRIJFS MODUS

M

Door te drukken op de  knop is het mogelijk om een van de volgende 6 bedieningsmodi te selecteren:



Comfort -modus:

De convector werkt om de ingestelde comforttemperatuur te bereiken en te handhaven, instelbaar tussen 100C en 300C.

Het symbool dat overeenkomt met de Comfort-modus licht op.

Het verwarmingssymbool licht op wanneer het verwarmingselement in werking is. In deze modus is de open raam functie actief (zie de Functie-knop).

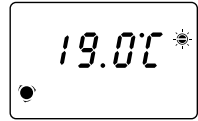

Comfort -modus -1:

De convector werkt om de ingestelde comforttemperatuur te bereiken en te handhaven, verminderd met 1 ° C.

Het symbool dat overeenkomt met de Comfort-modus licht op.

Het verwarmingssymbool licht op wanneer het verwarmingselement in werking is. In deze modus is de open raam functie actief (zie de Functie-knop).

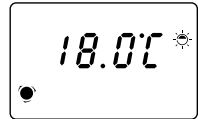

Comfort-modus -2:

De convector werkt om de ingestelde comforttemperatuur te bereiken en te handhaven, verminderd met 2 ° C.

Het symbool dat overeenkomt met de Comfort-modus licht op.

Het verwarmingssymbool licht op wanneer het verwarmingselement in werking is. In deze modus is de open raam functie actief (zie de Functie-knop).

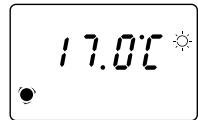

Eco-modus:

De convector werkt om de ingestelde comforttemperatuur te bereiken en te handhaven, verminderd met 3,5 ° C.

Het symbool dat overeenkomt met de Eco-modus licht op.

Het verwarmingssymbool licht op wanneer het verwarmingselement in werking is. In deze modus is de open raam functie actief (zie de Functie-knop).

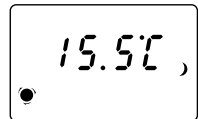

Anti vorst-modus:

De thermostaat wordt automatisch ingesteld op een temperatuur van 7 ± 3 ° C. Het symbool dat overeenkomt met de anti vorst-modus licht op.

Het verwarmingssymbool licht op wanneer het verwarmingselement in werking is. In deze modus is de open raam functie niet actief.

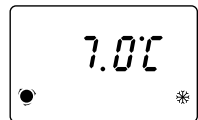

Programma modus:

De convector werkt om de temperatuur te bereiken en vast te houden die is ingesteld in het weekprogramma (zie de paragraaf over WEKELIJKSE PROGRAMMERING). Het symbool dat overeenkomt met de bedrijfsmodus (Comfort, Comfort-1, Comfort-2, Eco of Anti vorst-modus) licht op volgens de instellingen voor de huidige tijd en dag.

In deze modus is de open raam functie actief (zie de Functie-knop).



7. SPECIALE FUNCTIES

F

Door te drukken op de  knop is het mogelijk om een van de volgende 3 speciale functies te selecteren:



Reset-functie:

Door deze functie te activeren, worden alle instellingen hersteld naar de oorspronkelijke fabrieks-waarde. De comforttemperatuur is ingesteld op 19.0°C, het vooraf fabrieksmatig ingestelde programma is actief en de open-raam-functie is gedeactiveerd.

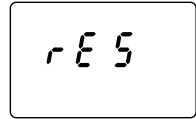

Om te resetten drukt u gedurende minstens 5 seconden op de -knop.

De convector wordt automatisch ingesteld in de Comfort-modus.

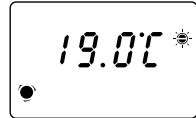

Open raam functie:

Met deze functie zal de convector een open raam detecteren.

Als tijdens de normale werking van de convector een sterke daling van de omgevingstemperatuur wordt waargenomen wordt, om energiever-spilling te verminderen, de anti vorst modus automatisch geactiveerd. Het open raam symbool en het anti vorst symbool knipperen om aan te geven dat de functie is geactiveerd.

De open raam detectie zal niet automatisch herstellen, door op een van de 5 knoppen van het bedieningspaneel te drukken zal de open raam detectie gedeactiveerd worden.

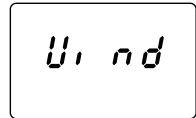



De juiste werking van de open raam functie is afhankelijk van de opstelling van de convector in de kamer, de aanwezigheid van tocht, de buitentemperatuur en de openingstijd van het venster.

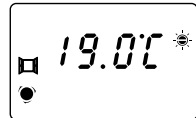

Activeer de functie door op  te drukken.

Het open raam-symbool knippert het display.



Deactiveer de functie door op de knop  te drukken.

Het open raam- symbool gaat uit op het display.

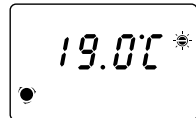



Lock-functie

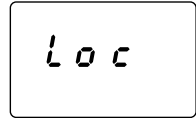

Door deze functie te activeren worden alle knoppen vergrendeld, hierdoor kunnen in het programma geen wijzigingen worden aangebracht.

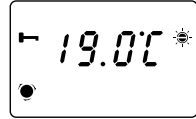

5" Activeer de functie door de knop  gedurende minstens 5 seconden ingedrukt te houden.

Het sleutelsymbool licht op het display op en de toetsen zijn vergrendeld.



5" Deactiveer de functie door de knoppen  en  tegelijkertijd gedurende minstens 5 seconden ingedrukt te houden.

Het sleutelsymbool gaat uit, de knoppen werken weer.

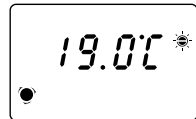

8. TEMPERAATUUR REGELING

De elektronische temperatuurregeling is gebaseerd op de temperatuur die de gebruiker instelt als COMFORT-temperatuur.

De temperatuurwaarden voor de modi Comfort-1, Comfort-2, Eco en Anti vorst worden automatisch berekend en kunnen niet rechtstreeks door de gebruiker worden aangepast. De referentietemperatuur wordt altijd op het display weergegeven samen met het symbool dat de geselecteerde bedieningsmodus weergeeft.

OPMERKING: De temperatuur gemeten door de sensor in de convector geeft altijd de omgevingstemperatuur in de onmiddellijke nabijheid van de convector aan en kan afwijken van de temperatuur die wordt gemeten in andere delen van de ruimte.

Dit verschil is van verschillende factoren afhankelijk, zoals:

- De installatiepositie: sommige delen van de kamer kunnen worden beïnvloed door stromingen of warme luchtzakken die de sensormeting kunnen veranderen;
- De installatie op een externe buitenmuur, die normaal kouder is dan binnenwanden, kan resulteren in een lagere temperatuurmeting dan de werkelijke kamertemperatuur;
- Onstabiele omstandigheden: elke temperatuurmeting moet onder stabiele bedrijfsomstandigheden worden uitgevoerd. Om deze reden mag de comforttemperatuur niet worden gewijzigd voordat 60 minuten zijn verstreken sinds de vorige wijziging. In feite is het niet mogelijk om te beoordelen of de kamertemperatuur correct wordt onderhouden door de convector als het temperatuurniveau in korte tijd continu wordt aangepast.

Als het verschil tussen de ingestelde temperatuur en de omgevingstemperatuur wordt gedetecteerd in stabiele toestand, moet u dit verschil berekenen en vervolgens het comforttemperatuurniveau op het product met de exact berekende verschilwaarde verhogen of verlagen.

9. DATUM EN TIJD INSTELLING

Instellen huidige tijd en datum:



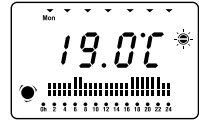

Blijf op de knop **M** drukken totdat de programmeer modus is geselecteerd.



Houd de **M** knop minimaal 3 seconden ingedrukt tot de dag van de week begint te knipperen.



Gebruik de knoppen  en  om de huidige datum te selecteren.



Druk op de knop **M** om te schakelen tussen dag- en tijdstelling.

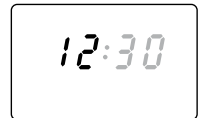

Gebruik de knoppen  en  om uren te selecteren.



Druk op de knop **M** om te schakelen tussen uur- en minuteninstelling.



Gebruik de knoppen  en  om minuten te selecteren.



Druk op de knop **M** om de instelling te beëindigen en terug te keren naar de programma modus



10. WEKELIJKS PROGRAMMA

Met de wekelijkse programmering kunt u de gewenste bedrijfsmodus instellen voor elk uur van de dag en voor elke dag van de week. De convector wordt vooraf ingesteld met het volgende weekprogramma:

Maandag-vrijdag

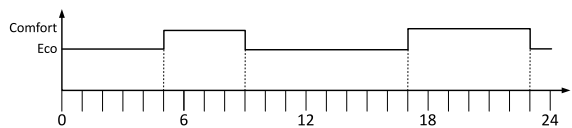

Zaterdag-Zondag

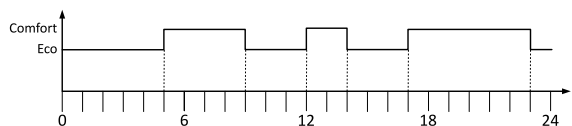

Om het programma te bekijken/wijzigen, gaat u als volgt te werk:



Druk op de knop **M** totdat de programma modus is geactiveerd.



Houd de knop **F** gedurende minstens 3 seconden ingedrukt om de programmeermodus te openen/wijzigen. Op de eerste dag (maandag) van de week beginnen de ingestelde temperatuur en het bijbehorende symbool te knipperen.

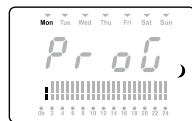

Gebruik de symbolen  en  om de verschillende tijden van de dag en te selecteren de knop **M** om de bedrijfsmodus van elk uur te wijzigen.



Telkens wanneer op de knop **M** wordt gedrukt, verandert de bedieningsmodus volgens de volgorde:



Comfort > Comfort-1 > Comfort-2 > Eco > Anti-freeze

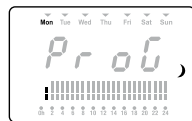



Druk op de knop **F** om de volgende dag te bekijken/wijzigen.



Als u de instellingen voor de ene dag naar een andere wilt kopiëren (volgende), gaat u als volgt te werk:



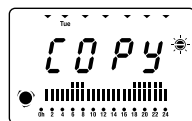

Selecteer de dag waarop u de instellingen wilt kopiëren en druk op gelijktijdig de knoppen  en  in. Het woord "COPY" verschijnt op het display en bevestigt dat het is opgeslagen

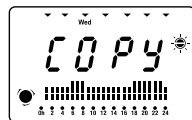

Druk op de F-knop om de dag te selecteren die u wilt programmeren met hetzelfde programma dat u zojuist hebt gekopieerd.



Druk opnieuw gelijktijdig op de knoppen  en  om het programma te "plakken" naar geselecteerde dag. Het woord PROG verschijnt op het display.



Druk op de knop **F** om de volgende dag te bekijken/wijzigen. De programmeer functie wordt beëindigd door opnieuw op de knop te drukken. Na het bekijken/wijzigen van de laatste dag van de week. Het display keert terug en toont de geprogrammeerde instellingen voor de huidige dag en tijd.



11. PROBLEMEN OPLOSSEN

In het geval van oververhitting wordt het verwarmingselement automatisch uitgeschakeld door de beveiliging op het apparaat. In dit geval:

- Zet de convector uit en laat hem ongeveer 15/20 minuten afkoelen.
- Verwijder alle andere mogelijke redenen van de oververhitting (bijvoorbeeld: obstructies voor de luchtinlaat/-uitlaatroosters, opeenhopingen van vuil).
- Schakel de convector opnieuw in en controleer of deze correct werkt.

12. ONDERHOUD

- Dit product vereist geen speciaal onderhoud
- Reinig het product eenmaal per 6 maanden met een droge doek
- Neem contact op met een erkend technisch servicecentrum als het product gerepareerd moet worden.
- Gebruik bij het vervangen van het netsnoer een 2x0,75mm² H05RR-F of 2x1,00 mm² H05RR-F <HAR> type. Deze werkzaamheden moet worden uitgevoerd door gekwalificeerd personeel en nooit door de eindgebruiker, dit om schade aan het apparaat te voorkomen en de persoonlijke veiligheid in niet gevaar te brengen.

13. JURIDISCHE MEDEDELING



Milieu en recycling:

Om schade tijdens het transport te voorkomen, is uw apparaat zorgvuldig verpakt. Wij verzoeken u ons bij de bescherming van ons milieu behulpzaam te zijn. Verwijder de verpakking daarom overeenkomstig de voor de afvalverwerking geldende nationale voorschriften.

Recycling van verouderde apparaten:

Toestellen met dit kenmerk horen niet thuis in de vuilnisbak en moeten apart worden ingezameld en gerecycled volgens de ter plaatse geldende voorschriften en wetgeving.

Informatie-eisen voor elektrische toestellen voor lokale ruimteverwarming

Type aanduiding(en): SIRIO					
Item	Symbol	Waarde	Eenheid	Item	Eenheid
Warmteafgifte				Type warmte-input, uitsluitend voor elektrische warmteopslagtoestellen (selecteer één)	
Nominale warmteafgifte	P_{nom}	(*)	kW	Handmatige sturing van de warmteopslag, met geïntegreerde thermostaat	nee
Minimale warmteafgifte (indicatief)	P_{min}	(**)	kW	Handmatige sturing van de warmteopslag, met kamer- en/of buitentemperatuurfeedback	nee
Maximale continue warmteafgifte	$P_{max,c}$	(***)	kW	Elektronische sturing van de warmteopslag, met kamer- en/of buitentemperatuurfeedback	nee
Aanvullend elektriciteitsverbruik				Door een ventilator bijgestane warmteafgifte	nee
Bij nominale warmteafgifte	$e_{l,max}$	0,000	kW	Type warmteafgifte/sturing kamertemperatuur (selecteer één)	
Bij minimale warmteafgifte	$e_{l,min}$	0,000	kW	Eentraps-warmteafgifte, geen sturing van de kamertemperatuur.	nee
In standby modus	$e_{l,SB}$	0,162	W	Twee of meer handmatig in te stellen trappen, geen sturing van de kamertemperatuur	nee
				Met mechanische sturing van de kamertemperatuur door thermostaat	nee
				Met elektronische sturing van de kamertemperatuur	nee
				Elektronische sturing van de kamertemperatuur plus dag-tijdschakelaar	nee
				Elektronische sturing van de kamertemperatuur plus week-tijdschakelaar	ja
				Andere sturingsopties (meerdere selecties mogelijk)	
				Sturing van de kamertemperatuur, met aanwezigheidsdetectie	nee
				Sturing van de kamertemperatuur, met openraamdetectie	ja
				Met de optie van afstandsbediening	nee
				Met adaptieve sturing van de start	nee
				Met beperking van de werkingstijd	nee
				Met black-bulbsensor	nee
Contact details	Uw dealer of Ermete Giudici S.p.A. - via L. da Vinci, 27 - 20090 Segrate (MI) Italy				

(*)	SIRIO 5 = 0,50	SIRIO 10 = 1,00	SIRIO 15 = 1,50	SIRIO 20 = 2,00
(**)	SIRIO 5 = 0,25	SIRIO 10 = 0,50	SIRIO 15 = 0,75	SIRIO 20 = 1,00
(***)	SIRIO 5 = 0,50	SIRIO 10 = 1,00	SIRIO 15 = 1,50	SIRIO 20 = 2,00

Bitte lesen Sie diese Anweisungen vor der Verwendung des Produkts aufmerksam durch, um Schäden oder in jedem Fall das Auftreten von Gefahrensituationen zu vermeiden. Jegliche Verwendung des Produkts, die von den Vorgaben in diesem Handbuch abweicht, kann Brände, elektrische Gefahren oder Verletzungen verursachen und macht die Garantie nichtig.

Die Garantie gilt nicht für Defekte, Verschlechterungen, Verluste, Verletzungen oder Schäden, die auf eine unsachgemäße Verwendung des Produkts zurückzuführen sind. Alle gesetzlichen Rechte in diesem Bereich bleiben garantiert. Keine Garantiebedingung kann die durch staatliche Gesetze geregelten Garantiebedingungen ausschließen oder abändern.

Entfernen Sie vor jeder Maßnahme sorgfältig die Verpackung und überprüfen Sie die perfekte Integrität des Produkts. Falls Defekte oder Beschädigungen festgestellt werden, installieren Sie das Gerät nicht und versuchen Sie auch nicht, es zu reparieren. Wenden Sie sich in diesem Fall bitte an den Händler.

Bewahren Sie die Verpackung nicht in der Reichweite von Kindern auf und entsorgen Sie die Teile in Einklang mit den geltenden Vorschriften.

1. FÜR IHRE SICHERHEIT

- Dieses Produkt ist für den Hausgebrauch bestimmt und nicht für die Verwendung in kommerziellen/industriellen Umgebungen oder auf Fahrzeugen, Booten oder Flugzeuge geeignet.
- Das Gerät kann von Kindern unter 8 Jahren und von Personen mit eingeschränkten physischen und sensorischen oder mentalen Fähigkeiten oder ohne Erfahrung oder notwendiges Wissen verwendet werden, sei denn unter Aufsicht oder nachdem diese Anweisungen in Bezug auf die sichere Verwendung des Geräts und Kenntnisse über die Gefahren in diesem Zusammenhang erhalten haben. Die Reinigung und die Wartung, die vom Benutzer auszuführen ist, darf nicht von Kindern ohne Aufsicht durchgeführt werden.
- Kinder unter 3 Jahren dürfen sich dem Produkt nicht nähern, wenn sie nicht konstant beaufsichtigt werden.
- Kinder zwischen 3 und 8 Jahren dürfen das Gerät nur ein- und ausschalten, sofern dieses gemäß den normalen Nutzungsbedingungen installiert und positioniert wurde und sie überwacht werden oder angemessen in Bezug auf die korrekte und sichere Verwendung des Produkts geschult wurden und seine Gefährlichkeit verstanden haben.
- Kinder im Alter zwischen 3 und 8 Jahren dürfen das Produkt nicht

anschließen, einstellen, reinigen oder an ihm Wartungsarbeiten ausführen.

- **ACHTUNG: Einige Teile dieses Produkts können sehr heiß werden und Verbrennungen verursachen. Besondere Aufmerksamkeit muss bei Anwesenheit von Kindern oder verletzbareren Personen geboten werden.**
- Vergewissern Sie sich, dass die Netzspannung den Daten auf dem Typenschild entspricht: 230V~, 50Hz.
- Das Produkt verfügt über eine doppelte Schutzwirkung vor Wasser: IPX0, wenn es als tragbares Produkt verwendet wird und IPX4, wenn es an der Wand installiert wird.
- Beachten Sie die Vorschriften des Landes, in dem das Produkt installiert wird in Bezug auf die Verwendung in unterschiedlichen Umgebungen. Wenn an der Wand installiert, kann es in den Badezimmern verwendet werden, SOFERN ES NICHT IN UNMITTELBARER NÄHE ZUR BADEWANNE ODER ZUR DUSCHE INSTALLIERT WIRD. Das Produkt darf daher nicht in den Bereichen installiert werden, die im Schema der Abbildung 1 als Volumen 1 angegeben sind. Wenn es als tragbares Produkt verwendet wird, vergewissern Sie sich, dass der Konvektor nicht von der Badewanne, von der Dusche oder vom Pool aus zugänglich ist.
- Stellen Sie den Konvektor während des Betriebs in eine sichere Position, d.h.:
 - in mindestens 1m Entfernung von entflammabaren Gegenständen oder Möbeln;
 - indem das Luftauslassgitter freigelassen wird: es darf sich kein Gegenstand in einem Umkreis von 1 m vom Auslassgitter befinden;
 - es darf niemals direkt unterhalb einer Steckdose positioniert werden.
- Lassen Sie nicht zu, dass Tiere oder Kinder mit dem Konvektor spielen oder diesen berühren. Achtung! Während des Betriebs kann das Luftauslassgitter sehr heiß werden (über 90°C);
- **WICHTIG: decken Sie es niemals ab, um Überhitzungen zu vermeiden.** Legen Sie niemals irgendeinen Gegenstand oder eine Decke auf das Gerät, während es in Betrieb ist. Dies steht eindeutig auf dem Gerät geschrieben oder wird durch das Symbol illustriert:



- Verwenden Sie den Konvektor nicht in Zimmern, die mit explosiven Gasen, durch Lösungsmittel und Lacke erzeugte Dämpfe oder in jedem Fall entzündlichen Dämpfen/Gasen gesättigt sind.
- Wenn das Kabel beschädigt ist, müssen Sie es ersetzen. Führen Sie diese Maßnahmen nicht allein aus, bringen Sie den Konvektor in ein befugtes Reparaturzentrum, da der Eingriff von Fachpersonal erforderlich ist, um jegliches Risiko von Beschädigungen zu vermeiden.
- Der Konvektor muss so positioniert werden, dass die Steckdose stets erreichbar ist.
- Installieren Sie das Produkt nicht an Wänden aus synthetischem Material.
- Verwenden Sie diesen Konvektor nicht, nachdem er heruntergefallen ist;
- Verwenden Sie ihn nicht, wenn sichtbare Zeichen auf Beschädigung des Konvektors bestehen;
- Verwenden Sie den Konvektor auf einer horizontalen und stabilen Oberfläche;
- **ACHTUNG:** Verwenden Sie den Konvektor nicht in kleinen Zimmern, wenn diese von Personen besetzt sind, die nicht in der Lage sind, das Zimmer allein zu verlassen, sei denn, sie stehen unter der Aufsicht irgendeiner für ihre Sicherheit verantwortlichen Person;
- **ACHTUNG:** Halten Sie, um das Brandrisiko zu vermeiden, Stoffe, Gardinen oder jedes andere entflammbare Material auf mindestens 1m Abstand vom Luftaustrittsgitter.

2. WANDMONTAGE

- Installieren Sie den Konvektor mit dem nach oben gerichteten Luftaustrittsgitter in einer horizontalen Position.
- Dieser Konvektor ist doppelt elektrisch isoliert (Klasse II), daher ist der Erdungsanschluss nicht erforderlich;
- Dieser Konvektor muss unter Befolgung der im Installationsland geltenden Vorschriften installiert werden.
- In feuchten Umgebungen wie Badezimmern und Küchen muss der Anschluss an das Stromnetz mindestens 25 Höhe vom Boden betragen. Die Geräte, die vom Stromnetz getrennt werden müssen, erlauben die vollständige Abtrennung unter den Bedingungen der Überspannungskategorie III.
- Das Gerät muss an der Wand unter Einhaltung der Mindestabstände von der Decke, vom Boden und von den Seitenwänden, die in der Abbildung 2 angegeben sind, installiert werden. Zu diesem Zweck muss der Stützbügel an der Wand unter Einhaltung der Abstände, die in Abbildung 3 und in der nachfolgenden Tabelle angegeben sind, befestigt werden.
- Um mit der Installation fortzufahren:
 - Entfernen Sie den Bügel vom Produkt;
 - Bohren Sie unter Einhaltung der in Abbildung 3 angegebenen und in der nachfolgenden Tabelle spezifizierten Abstände 4 Löcher in die Wand:

MODELL	A	B	C
SIRIO 5	205mm	180mm	357mm
SIRIO 10	290mm	260mm	400mm
SIRIO 15	270mm	480mm	400mm
SIRIO 20	250mm	700mm	400mm

- Befestigen Sie die Halterung mit den für diese Wandart passenden Dübeln und Schrauben;
- Stellen Sie sicher, dass die zuvor beschriebenen Mindestabstände eingehalten werden;
- Nähern Sie das Produkt der Halterung an, bis die unteren Haken der Halterung in die auf dem hinteren Paneel vorhandenen Schlitz greifen, wie in Abbildung 4 angegeben;
- Drehen Sie den oberen Teil des Produkts in Richtung Wand bis es blockiert und vergewissern Sie sich, dass die 2 oberen Haken der Halterung, wie in Abbildung 5 angegeben, einrasten;
- Verriegeln Sie die 2 oberen Haken der Halterung mit den im Lieferumfang enthaltenen Schrauben, wie in Abbildung 6 angegeben.

3. BEFESTIGUNG DER RÄDER (OPTIONAL)

- Der Konvektor kann auch als tragbares Produkt verwendet werden, indem Sie die separat gelieferten Räder kaufen.
- Für die Befestigung der Räder:
 - überprüfen Sie die korrekte Ausrichtung gemäß den Angaben in Abbildung 7;
 - befestigen Sie jede der 2 Halterungen mit den Rädern, indem Sie die im Lieferumfang enthaltenen Schrauben, wie in Abbildung 8 angegeben, verwenden. Die Schrauben können per Hand befestigt werden und erfordern kein Werkzeug.

4. BESCHREIBUNG DER BEFEHLE

- Der Konvektor ist mit einer Taste zum Einschalten und Ausschalten ausgestattet, die sich auf der rechten Seite befindet. Beim Ausschalten des Produkts werden die elektrischen Komponenten nicht mehr unter Spannung sein.
- Die folgenden Befehle wurden auf der Vorderseite des Produkts integriert (Abbildung 10):



Multifunktions-Display für die Anzeige des Betriebs- und Aktivierungszustands der Funktionen.

	Comfort
	Comfort - 1 °C
	Comfort - 2 °C
	Eco -3,5 °C
	Frostschutz
	Tastatursperre
	Erkennung eines geöffneten Fensters
	Erwärmung läuft



Auswahltaete des Betriebsmodus.



Auswahltaete der Sonderfunktionen.



Navigationstaste innerhalb der verschiedenen Menüs.



Taste zur Aktivierung oder Deaktivierung des Standby-Status

5. EINSCHALTEN UND AUSSCHALTEN



Die Speisung des Produkts wird über eine elektromechanische Ein- und Ausschalttaste gesteuert. Das Ausschalten des Produkts mit Hilfe dieser Taste verursacht die Unterbrechung der Speisung der elektronischen Platinen und die daraus folgende Löschung der aktuellen Uhrzeit und des aktuellen Datums. Wir empfehlen, diesen Schalter nur zu verwenden, wenn das Produkte für einen längeren Zeitraum nicht verwendet wird. Verwenden Sie hingegen die Einschalt-/ Stand-by-Taste auf dem Bedienfeld für kurze Unterbrechungen bei der Verwendung des Produkts. Auf diese Weise gehen die zuvor eingegebenen Einstellungen nicht verloren.

Zum Zeitpunkt des Einschaltens aktiviert der Kollektor den zuletzt vor dem Ausschalten oder vor einem Stromausfall verwendeten Modus. Die Uhrzeit wird erneut auf 12:00 Uhr und der Wochentag auf Montag eingestellt.

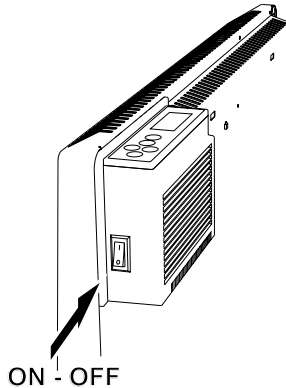

Verwenden Sie die Einschalt- / Stand-by-Taste, um den Konvektor ein- und auszuschalten, ohne die gespeicherte Uhrzeit zu verlieren.

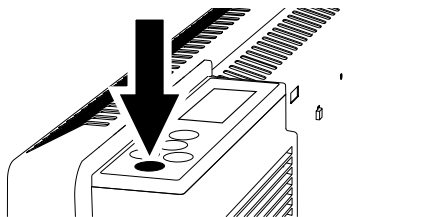

6. BETRIEBSMODUS

M

Das Drücken der Taste  ermöglicht die Auswahl eines der folgenden 6 Betriebsmodi:



Comfort -modus:

Der Konvektor funktioniert, um die eingestellte Comfort-Temperatur zu erreichen und beizubehalten.

Das Symbol, das dem Comfort-Modus entspricht, schaltet sich ein.

Das Symbol in Bezug auf die Erwärmung schaltet sich ein, wenn das Heizelement in Betrieb ist. In diesem Modus ist die Funktion zur Erkennung des geöffneten Fensters verfügbar. (siehe die Taste FUNKTIONEN).

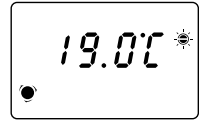

Comfort -modus -1:

Der Konvektor funktioniert, um die eingestellte Comfort-Temperatur, reduziert um 1°C, zu erreichen und beizubehalten.

Das Symbol, das dem Comfort-1-Modus entspricht, schaltet sich ein.

Das Symbol in Bezug auf die Erwärmung schaltet sich ein, wenn das Heizelement in Betrieb ist. In diesem Modus ist die Funktion zur Erkennung des geöffneten Fensters verfügbar (siehe die Taste FUNKTIONEN).

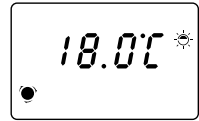

Comfort-modus -2:

Der Konvektor funktioniert, um die eingestellte Comfort-Temperatur, reduziert um 2°C, zu erreichen und beizubehalten.

Das Symbol, das dem Comfort-2-Modus entspricht, schaltet sich ein.

Das Symbol in Bezug auf die Erwärmung schaltet sich ein, wenn das Heizelement in Betrieb ist. In diesem Modus ist die Funktion zur Erkennung des geöffneten Fensters verfügbar (siehe die Taste FUNKTIONEN).

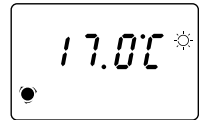

Eco-modus:

Der Konvektor funktioniert, um die eingestellte Comfort-Temperatur, reduziert um 3,5°C, zu erreichen und beizubehalten.

Das Symbol, das dem Eco-Modus entspricht, schaltet sich ein.

Das Symbol in Bezug auf die Erwärmung schaltet sich ein, wenn das Heizelement in Betrieb ist. In diesem Modus ist die Funktion zur Erkennung des geöffneten Fensters verfügbar (siehe die Taste FUNKTIONEN).

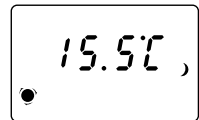

Frostschutz-modus:

Der Thermostat wird automatisch auf die Temperatur von 7±3°C eingestellt.

Das Symbol, das dem Frostschutz-Modus entspricht, schaltet sich ein.

Das Symbol in Bezug auf die Erwärmung schaltet sich ein, wenn das Heizelement in Betrieb ist. In diesem Modus ist die Funktion zur Erkennung des geöffneten Fensters nicht verfügb.

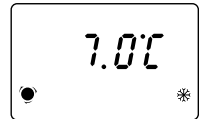

Programmiert modus:

Der Konvektor funktioniert, um die im Wochenprogramm eingestellte Temperatur zu erreichen und beizubehalten (siehe Absatz in Bezug auf die WOCHENPROGRAMMIERUNG).

Das Symbol, das dem Betriebs-Modus entspricht (Comfort, Comfort-1, Comfort-2, Eco oder Frostschutz) schaltet sich in Abhängigkeit von den vorgesehenen Einstellungen für die aktuelle Uhrzeit und den aktuellen Tag ein. In diesem Modus ist die Funktion zur Erkennung des geöffneten Fensters verfügbar (siehe die Taste FUNKTIONEN)



7. SONDERFUNKTIONEN

F

Das Drücken der Taste  erlaubt die Auswahl einer der folgenden 3 Sonderfunktionen:



Reset-Funktion:

Durch Aktivierung dieser Funktion werden alle Einstellungen auf den anfänglichen Fabrikwert zurückgesetzt. Die Comfort-Temperatur wird auf 19,0°C eingestellt, das voreingestellte Programm, das im entsprechenden Abschnitt beschrieben wird und die Funktion zur Erkennung eines geöffneten Fensters werden deaktiviert.

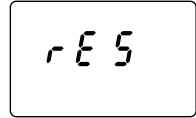

Drücken Sie, um den RESET auszuführen, die Taste  für wenigstens 5 Sekunden.

Der Konvektor wird automatisch auf den Comfort-Modus eingestellt.

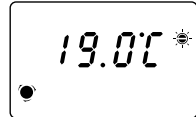

Funktion zur ERKENNUNG EINES GEÖFFNETEN FENSTERS:

Diese Funktion erlaubt das Erkennen eines geöffneten Fensters und die automatische Einstellung des Frostschutz-Modus.

Falls ein plötzlicher Abfall der Umgebungstemperatur während des normalen Betriebs erfasst wird, wird automatisch der Frostschutz-Modus aktiviert, um die Energieverschwendung zu reduzieren.

Das Symbol des Fensters und das Frostschutzsymbol blinken, um die Aktivierung der Funktion anzuzeigen.

Das Zurücksetzen des normalen Betriebs erfolgt nicht automatisch, sondern man es erreicht über das Drücken irgendeiner der 5 Tasten des Produkts.

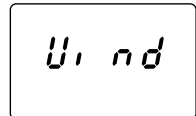

Der korrekte Betrieb dieser Funktion kann von der Positionierung des Produkts im Raum, vom Vorhandensein von Zugluft und von der Länge der Öffnungszeit des Fensters abhängen.



Aktivieren Sie die Funktion durch Drücken der Taste 

Das Symbol des Fensters schaltet sich auf dem Display ein

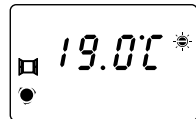

Deaktivieren Sie die Funktion durch Drücken der Taste 

Das Symbol des Fensters schaltet sich aus

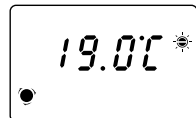



SPERR-Funktion

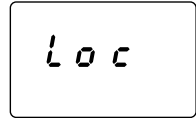

Durch Aktivierung dieser Funktion werden die Tasten deaktiviert, um unerwünschte Abänderungen der Betriebseinstellungen zu verhindern.

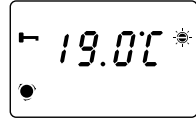

5" Aktivieren Sie die Funktion durch Drücken der Taste  für mindestens 5 Sekunden.

Das Schlüsselsymbol schaltet sich auf dem Display ein und die Tasten werden gesperrt.



Deaktivieren Sie die Funktion durch gleichzeitiges Drücken der Tasten  und  und für mindestens 5 Sekunden.

Das Schlüsselsymbol schaltet sich aus und die Tasten funktionieren wieder.

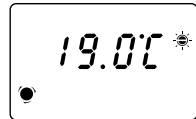

8. KONTROLLE DER TEMPERATUR

Die elektronische Kontrolle der Temperatur basiert auf dem Wert, den der Benutzer der COMFORT-Temperatur zuweist.

Die Werte der Temperaturen für die Modi Comfort-1, Comfort-2, Eco und Frostschutz werden automatisch berechnet und können nicht direkt vom Benutzer verändert werden. Die Bezugstemperatur wird immer auf dem Display zusammen mit dem Symbol, das den ausgewählten Betriebsmodus darstellt, angegeben.

HINWEIS: Die mit dem Sensor im Produkt gemessene Temperatur zeigt immer die Umgebungstemperatur in der unmittelbaren Nähe des Produktes an und kann von der mit anderen Instrumenten in anderen Bereichen des Zimmers gemessenen Temperatur abweichen. Diese Differenz kann von unterschiedlichen Faktoren abhängen, wie zum Beispiel:

- Die Installationsposition: einige Bereiche des Zimmers können Luftzügen oder warmen Luftlöchern ausgesetzt sein, die die Messung des Sensors verändern;
- Die Installation an der Außenwand, die normalerweise kälter als die Innenwände ist, kann die Messung einer niedrigeren Temperatur im Vergleich zur realen Umgebungstemperatur verursachen;
- Instabile Bedingungen: jede Bewertung muss unter stabilen Betriebsbedingungen ausgeführt werden. Aus diesem Grund darf die Comfort-Temperatur nicht geändert werden, bevor nicht 60 Minuten seit der vorherigen Abänderungen verstrichen sind.

Es ist in der Tat nicht möglich, zu bewerten, ob die Umgebungstemperatur korrekt vom Produkt beibehalten wird, wenn das Temperaturniveau kontinuierlich in kurzen Zeiträumen verändert wird.

Wenn die Differenz zwischen der eingestellten Temperatur und der Umgebungstemperatur unter stabilen Bedingungen erfasst wurde, berechnen Sie diese Differenz und erhöhen oder reduzieren Sie das Niveau der Comfort-Temperatur auf dem Produkt um den exakten Wert der berechneten Differenz

9. EINSTELLUNG DES TAGES UND DER UHRZEIT

Um die aktuelle Uhrzeit und den aktuellen Tag einzustellen, müssen Sie wie folgt vorgehen:





Drücken Sie die Taste **M** bis zur Auswahl des programmierten Modus.



Drücken Sie die Taste **M** für mindestens 3 Sekunden bis der Wochentag anfängt zu blinken.





Verwenden Sie die Tasten  und  um den aktuellen Tag auszuwählen.

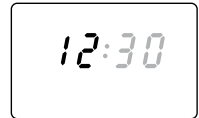

Drücken Sie die Taste **M** um von der Einstellung des Tages zu der Stunde zu wechseln.





Verwenden Sie die Tasten  und  für die Auswahl der aktuellen Stunde.



Drücken Sie die Taste **M** um von der Einstellung der Stunde zu der Minuten zu wechseln.



Verwenden Sie die Tasten  und  für die Auswahl der aktuellen Minuten.



Drücken Sie die Taste **M** um die Einstellung abzuschließen und in den programmierten Modus zurückzukehren



10. WOCHENPROGRAMMIERUNG

Die Wochenprogrammierung erlaubt für jede Stunde des Tages und für jeden Tag der Woche die Einstellung des gewünschten Betriebsmodus. Der Konvektor wird voreingestellt mit dem folgenden Wochenprogramm geliefert:

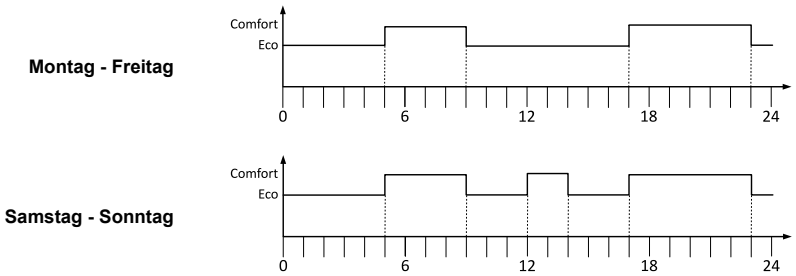

Um das Programm anzuzeigen/abzuändern, müssen Sie wie folgt vorgehen:



Drücken Sie die Taste **M** bis zur Aktivierung des programmierten Betriebsmodus.



Drücken Sie mindestens für 3 Sekunden die Taste **F** um in den Modus der Anzeige/Abänderung der Programmierung zu gelangen. Der erste Tag der Woche, die eingestellte Temperatur und das entsprechende Symbol beginnen zu blinken.

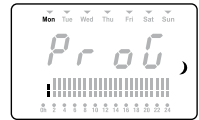

Verwenden Sie die Tasten **▲** und **▼** um die unterschiedlichen Stunden des Tages auszuwählen und um den Betriebsmodus jeder Stunde abzuändern.



Bei jedem Drücken der Taste **M** ändert sich der Betriebsmodus in folgender Reihenfolge



Comfort > Comfort-1 > Comfort-2 > Eco > Frostschutz

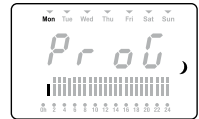

Drücken Sie die Taste **F** um auf die Anzeige/Abänderung des nachfolgenden Tages zu gelangen.



Falls Sie die Einstellungen eines Tages auf einen anderen (nachfolgenden) kopieren möchten, müssen Sie wie folgt vorgehen:



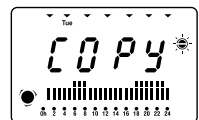

Wählen Sie den Tag, dessen Einstellungen Sie kopieren möchten und drücken Sie gleichzeitig die Tasten **▲** und **▼**. Die Schrift "COPY" erscheint auf dem Display zur Bestätigung der erfolgten Speicherung





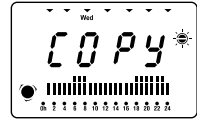

Drücken Sie die Taste F, um den Tag, den Sie mit demselben soeben kopierten Programm programmieren möchten, auszuwählen.

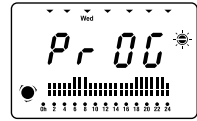

Drücken Sie erneut zusammen die Tasten  und  um das Programm in den ausgewählten Tag einzufügen. Auf dem Display erscheint wieder die Schrift PROG.



Drücken Sie die Taste  um zur Anzeige/Abänderung des nachfolgenden Tages zu gelangen.

Das Verfahren endet durch erneutes Drücken der Taste nach der Anzeige/Abänderung des letzten Wochentages. Das Display zeigt wieder die Programmereinstellungen für den aktuellen Tag und die aktuelle Stunde an.



11. FEHLERBEHEBUNG

Bei Überhitzung deaktiviert der Sicherheitsschutz innerhalb des Produkts sowohl den Widerstand als auch den Motor. In diesem Fall:

- Schalten Sie den Konvektor aus und lassen Sie ihn für etwa 15/20 Minuten abkühlen;
- Entfernen Sie jegliche Ursache der Überhitzung (z.B.: Verstopfung des Luftauslassgitters, Reste von Verschmutzungen auf dem Produkt, usw.);
- Schalten Sie den Konvektor erneut ein und überprüfen Sie den korrekten Betrieb

12. WARTUNG

- Dieses Produkt erfordert keine spezielle Wartung.
- Reinigen Sie mindestens alle 6 Monate das Produkt mit einem trockenen Tuch.
- Falls das Produkt repariert werden muss, wenden Sie sich bitte an ein qualifiziertes Servicecenter.
- Verwenden Sie bei Ersatz des Stromversorgungskabels in Abhängigkeit vom Konvektormodell den Typ 2x0,75mm² H05RR-F oder 2x1,00mm² H05RRF<HAR>. Diese Situation muss von qualifizierten Technikern ausgeführt werden und niemals vom Endnutzer, um eine Beschädigung des Produkts und jedes Risiko für Personen zu vermeiden.

13. GESETZLICHE MITTEILUNGEN



Umweltschutz und Recycling:

Damit Ihr Gerät während des Transports keine Schäden erleidet, wurde es sorgfältig verpackt. Um zum Umweltschutz beizutragen, bitten wir Sie, das für die Verpackung des Geräts verwendete Material angemessen zu entsorgen.

Entsorgung von gebrauchten Geräten:

Die Geräte, die das nebenstehende Zeichen tragen, dürfen nicht zusammen mit dem Hausmüll entsorgt werden, sondern müssen getrennt gesammelt und entsorgt werden. Die Entsorgung von gebrauchten Geräten muss fachgerecht in Einklang mit den lokal geltenden Vorschriften und Gesetzen erfolgen.

Obligatorische Informationen für elektrische Geräte für das Heizen von Räumen

Modellkennung: SIRIO					
Daten	Symbol	Wert	Einheit	Daten	Einheit
Thermische Leistung				Art der thermischen Leistung, nur für elektrische Speichergeräte für das Heizen von Räumen (nur eine Option angeben)	
Thermische Nennleistung	P_{nom}	(*)	kW	manuelle Kontrolle der thermischen Belastung, mit integrier-tem Thermostat	nein
Thermische Mindestleistung (indikativ)	P_{min}	(**)	kW	manuelle Kontrolle der thermischen Belastung, mit Nachprüfung der Umgebungstemperatur und/oder Außentemperatur	nein
Maximale kontinuierliche thermische Leistung	$P_{max,c}$	(***)	kW	elektronische Kontrolle der thermischen Belastung, mit Nachprüfung der Umgebungstemperatur und/oder Außentemperatur	nein
Hilfsstromverbrauch				vom Ventilator unterstützte thermische Leistung	nein
Bei thermischer Nennleistung	eI_{max}	0,000	kW	Art der thermischen Leistung/Kontrolle der Umgebungstemperatur (nur eine Option angeben)	
Bei thermischer Mindestleistung	eI_{min}	0,000	kW	einphasige thermische Leistung ohne Kontrolle der Umgebungstemperatur	nein
Im Stand-by-Modus	eI_{SB}	0,162	W	zwei oder mehrere manuelle Phasen ohne Kontrolle der Umgebungstemperatur	nein
				mit Kontrolle der Umgebungstemperatur mittels mechanischem Thermostat	nein
				mit elektronischer Kontrolle der Umgebungstemperatur	nein
				mit elektronischer Kontrolle der Umgebungstemperatur und Tagestimer	nein
				mit elektronischer Kontrolle der Umgebungstemperatur und Wochentimer	ja
				Weitere Kontrolloptionen (es ist möglich, mehrere Optionen auszuwählen)	
				Kontrolle der Umgebungstemperatur mit Anwesenheitserkennung	nein
				Kontrolle der Umgebungstemperatur mit Erkennung eines geöffneten Fensters	ja
				mit Option der Fernkontrolle	nein
				mit anpassbarer Startkontrolle	nein
				mit Begrenzung der Betriebszeit	nein
				mit Schwarzkugelsensor	nein
Kontakte	Ermete Giudici S.p.A. - via L. da Vinci, 27 - 20090 Segrate (MI) Italien				

(*) SIRIO 5 =0,50

SIRIO 10 = 1,00

SIRIO 15 = 1,50

SIRIO 20 = 2,00

(**) SIRIO 5 =0,25

SIRIO 10 = 0,50

SIRIO 15 = 0,75

SIRIO 20 = 1,00

(***) SIRIO 5 =0,50

SIRIO 10 = 1,00

SIRIO 15 = 1,50

SIRIO 20 = 2,00

